

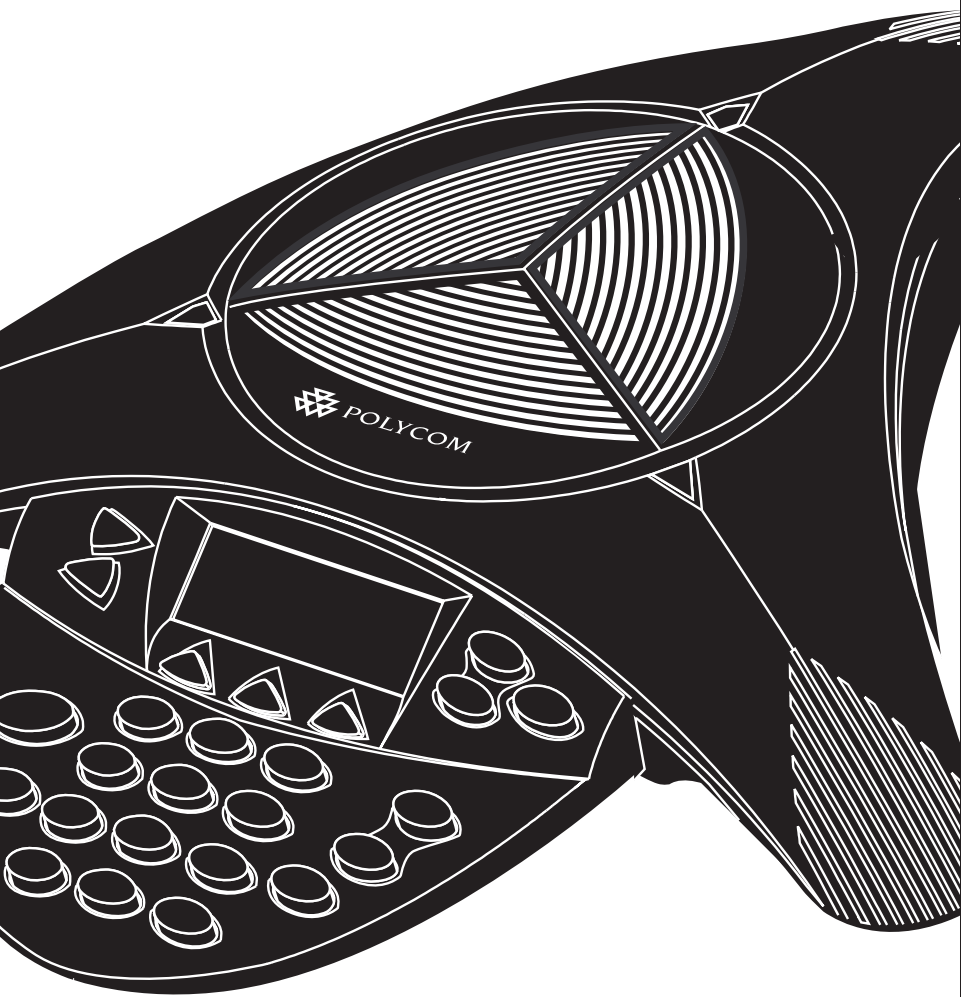

SoundStation 2W™

USER GUIDE / ADMINISTRATOR GUIDE



User Guide and Administrator Guide

IMPORTANT SAFETY INSTRUCTIONS

When using your telephone equipment, the following safety precautions should always be followed to reduce the risk of fire, electric shock, and injury to people.

- Read and understand all instructions.
- Follow all warnings and instructions marked on the equipment.
- Installation must be performed in accordance with all national wiring rules.
- The outlet to which this equipment is connected must be installed near the equipment, and must always be readily accessible.
- This equipment can be hazardous if immersed in water. To avoid the possibility of electrical shock, do not use this equipment while you are in the bathtub or shower, or when you are wet. If you accidentally drop the equipment into water, do not retrieve it until you have first unplugged all cords. Do not reconnect this equipment until it has dried thoroughly.
- Avoid using this equipment during electrical storms in your immediate area. There is a remote risk of electric shock from lightning. Urgent calls should be brief. Even though protective measures may have been installed to limit electrical surges from entering your home or business, absolute protection from lightning is impossible.
- If you suspect a natural gas leak, report it immediately, but use a telephone away from the area in question. The SoundStation2W™'s electrical contacts could generate a tiny spark. While unlikely, it is possible that this spark could ignite heavy concentrations of gas.
- Never push objects of any kind into the SoundStation2W™ through housing slots as they may touch hazardous voltage points or short out parts that could result in a risk of electric shock. Never spill liquid of any kind on the telephone. If liquid is spilled, contact service personnel.
- To reduce the risk of electric shock, do not disassemble SoundStation2W™. Opening or removing covers may expose you to hazardous voltages. Using incorrectly reassembled equipment can cause electric shock. If your telephone equipment does not work properly, refer to the section describing how to connect service.
- For technical support contact Polycom Support at <http://esupport.polycom.com>.
- Never install telephone wiring during a lightning storm.
- Never install telephone jacks in wet locations unless the jack is specifically designed for wet locations.
- Never touch uninsulated telephone wires or terminals unless the telephone line has been disconnected from the network interface.
- Always use caution when installing or modifying telephone lines.

SAVE THESE INSTRUCTIONS

Table of Contents

Thank You	5
Overview	5
Parts List.....	6
Setting up SoundStation2W™	7
Features.....	9
LED Indicators.....	9
Buttons	9
Understanding the Display	9
Wireless Technology	10
Security.....	10
Mobile Phone Mode.....	11
Using SoundStation2W™	12
Placing a Call	12
Answering a Call.....	12
Answering a Second Call.....	12
Ending a Call	13
Call Hold.....	13
Call Mute.....	13
Call Timer	13
Redial.....	14
Speed Dial a Number	14
Dialing Using the Phone Book.....	15
Ringer Volume Adjustment.....	15
Dial Tone Adjustment.....	15
Speaker Volume Adjustment	15
Display Contrast Adjustment.....	15
Ring Type Selection	16
Backlight Adjustment.....	16
Language.....	17
Conferencing - using the  button.....	17
Adding a call	17
Bridge Soft Key.....	18
Phone Book	19
View System Information	21
Standby Mode	22
Charging.....	23
Auxiliary Audio Output.....	24
Paging the Console.....	25
LCD Messages.....	25

Table of Contents

Troubleshooting	26
No Signal.....	26
No Dial Tone	26
Does Not Ring.....	26
Flickering LCD	26
Keypad Input Doesn't Register.....	26
Muffled or "in a well" Reception	26
Short Silences, Echoes, or Clipped Speech	27
Physical Damage	27
For Best Performance	27
Administrative Setup - Overview	29
Passcode	30
Location Information.....	31
Phone System.....	33
Flash Timing.....	34
Diagnostics	35
Mic (Microphone) Test	35
Console SPKR (Speaker) Test	35
Restore Defaults	36
Software Upgrade	36
Specifications and Warranty Information..	37
Limited Warranty and Limitation of Liability.....	38
FCC Compliance	40
Exhibit J - Customer Information	42
CE Mark R and TTE Directive	40
Safety Notices	41

Thank You

Thank you for choosing the Polycom SoundStation2W™. In this User Guide, you will find everything you need to quickly set up, use, and manage your new conference telephone. Be sure to verify with your System Administrator that your network

is prepared for configuring your SoundStation2W™ telephone. Lastly, it is important that you read the Parts List, and the Safety Notices section in this guide before you begin using the SoundStation2W™.

Overview

SoundStation2W™ is Polycom's next-generation, wireless conference phone that gives users the freedom to conference wherever team collaboration is important - even in rooms where there are no phone lines. With better voice quality than the original SoundStation, standard 2.4 GHz (WDCT) or 1.9 GHz (DECT) technology with voice en-

ryption, up to 24 hours of talk time, and the ability to dial through a mobile telephone, the SoundStation2W™ is the new standard for everyday conferencing. The SoundStation2W™ is a circuit switched platform compatible with any analog telephone line or analog terminal adapter.

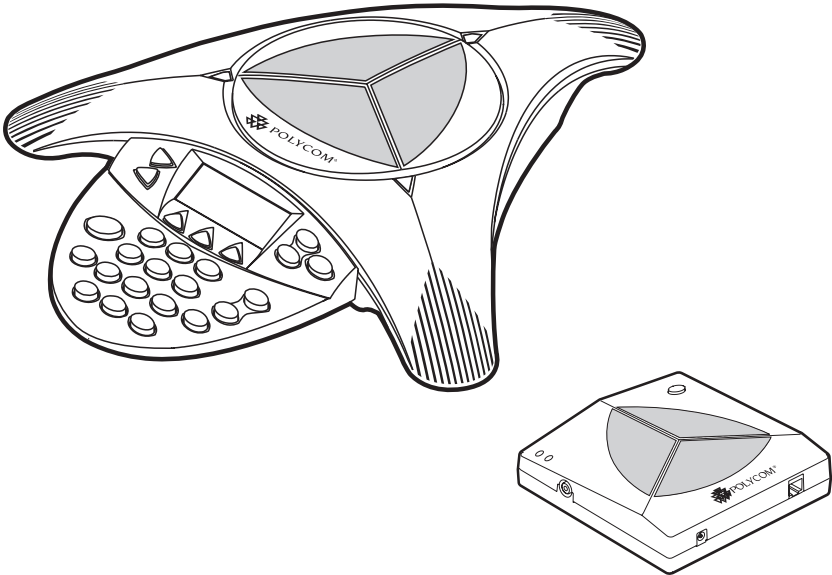

Parts List

The following items are included in your SoundStation2W™ package. Check this list before installation to ensure that you have re-

ceived each item. If you are missing any items, please contact your SoundStation2W™ reseller.

SoundStation2W™ console

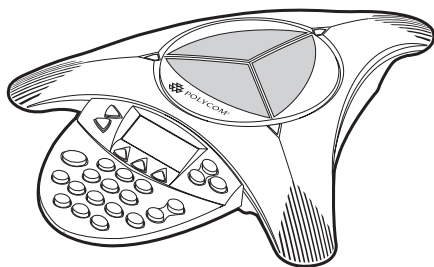

SoundStation2W™ base

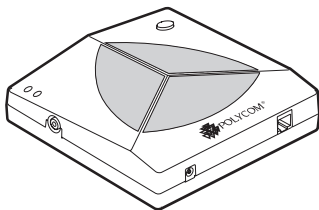

Mobile telephone connector



Registration card



Battery pack

-2 Cell Pack for SoundStation2W™ Basic
-4 Cell Pack for SoundStation2W™ EX

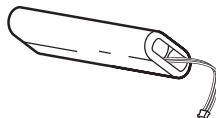

Console Charging module

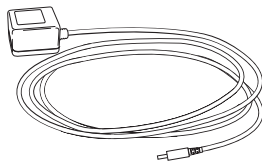

Base power supply

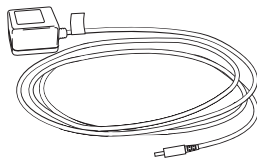

Telephone cord

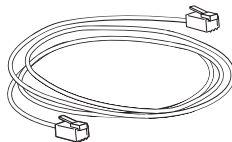

Setting up SoundStation2W™

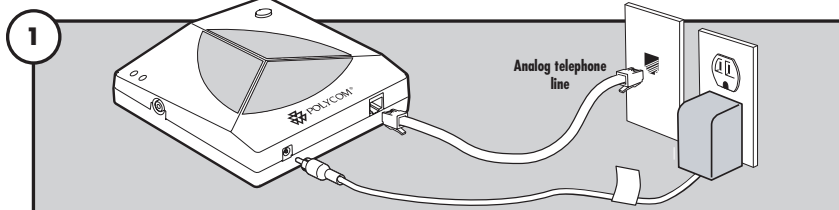

Connect base station to power and analog phone line.

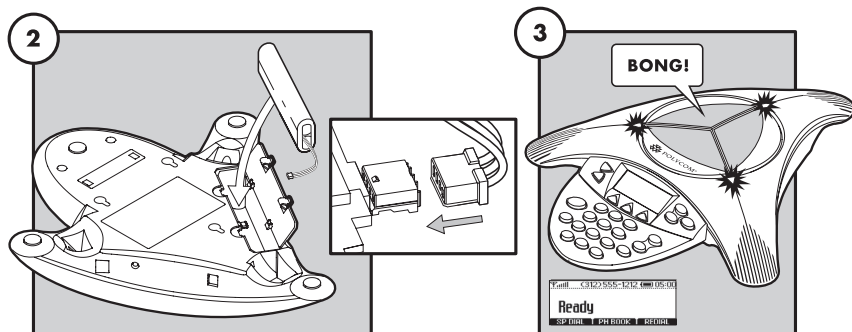

Install battery.

Wait for phone to register to base station.

Ready State

SoundStation2W™ will display a Ready message after successfully communicating with the base upon

power up. The Ready message is also shown after a call is completed and the phone is available for the next call.



- For best performance, charge the console for a full charging cycle (4 hours for BASIC, 8 hours for EX) prior to first use.

Mounting Options

Both the base station and the console can be wall mounted if desired. The base station can also be mounted under a table. The appropriate mounting screw holes are provided on the back surfaces.

The console can also be locked in place using a standard laptop security cable. This feature is designed for rooms where it is important to ensure that the phone does not get removed from its home location, and where it is desirable to eliminate the analog phone cable to the wall. There is a locking grommet on the side of the console designed to accept the lock end of the cable.

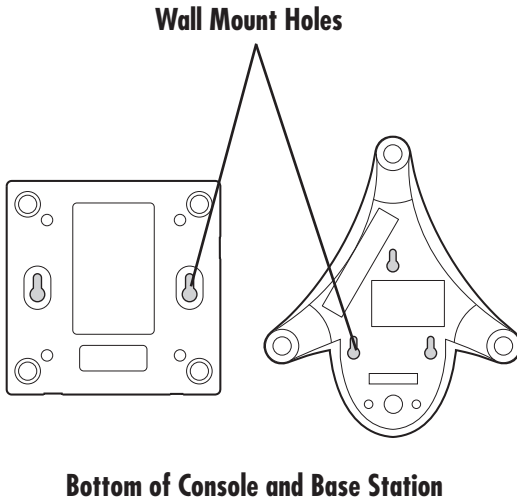

Features

LED Indicators

The LEDs located on the top of your SoundStation2W™ indicate the current status of your conference telephone:

- Green - your call is in progress.
- Blinking green - a call is incoming.
- Red - your call is muted.
- Blinking Red - your call is on hold.

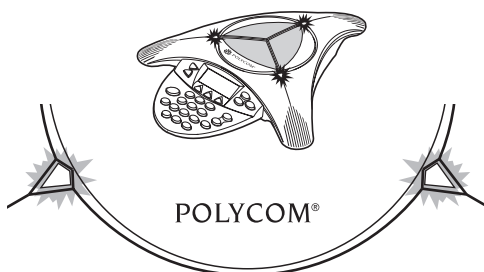

Buttons

Menu

Displays a menu of settings and options.

Exit

Exits from current screen to previous menu.

Soft Keys

The screen will display labels for these keys, to identify their context-sensitive functions.

Phone

Answers incoming calls, dials a call, ends a call, and provides dial tone.

Conference

Call, join, or delete additional call participants during a conference call.

Dial Pad

These 12 keys provide the 10 digits, the 26 alphabetic characters, and special characters available in context sensitive applications.

Scroll

Navigate up or down through displayed lists.

Select

Choose a menu item.

Volume



Use these to adjust the volume of the handset, headset, speaker, and ringer, as well as the display contrast.

Mute

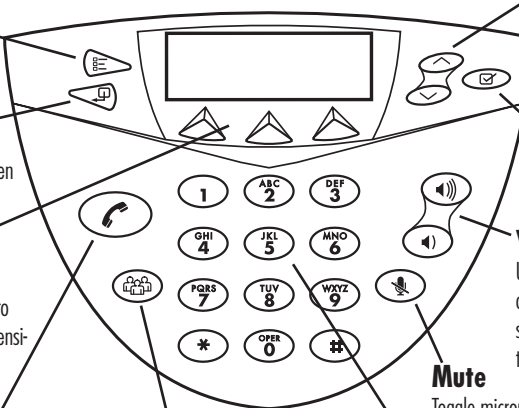
Toggle microphone on or off during a conversation.



Understanding the Display

Signal Strength  **Battery Life** 

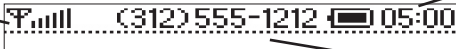
Information Area  **This Phone's Number** (312) 555-1212 **05:00**

Soft Key Functions
The screen will display labels for these keys, to identify their context-sensitive functions.

SP DIAL | **PH BOOK** | **REDIAL**

Wireless Technology

SoundStation2W™ comes in two different formats. The product uses either 2.4 GHz WDCT (Worldwide Digital Cordless Telecommunications) or 1.9 GHz DECT (Digital Enhanced Cordless Telecommunications) standard technology. WDCT is widely used in North America, South America, and China, while DECT is used in Europe, parts of Asia, and Australia. WDCT and DECT are Digital Spread Spectrum protocols which are reliable, secure, and support excellent voice quality and a wide range of dialing features. Digital Spread Spectrum has been used by the military for many years because there is a low probability of signal interception and interference.

Digital Spread Spectrum technology breaks the voice stream into small fragments and spreads them over a wide range of frequencies for transmission to a receiver. Only the receiver that is uniquely registered to the

transmitter will be able to reassemble the signal to deliver the voice stream. The SoundStation2W™ console and base station act as both transmitters and receivers. The console will only reassemble the signal sent from its matching base station and vice versa. Accordingly, the console will operate within 150 feet of the paired base station. The one-to-one pairing of console and base station ensures secure voice signal transmission.

The SoundStation2W™ implements Digital Spread Spectrum using frequency hopping encoding. Frequency hopping transmits the audio signal fragments over rapidly switching frequencies in the 2.4 GHz and 1.9 GHz bands. Frequency hopping enables the SoundStation2W™ to automatically detect and avoid sources of potential interference such as other SoundStation2W™ phones or 802.11x WLAN clients.

Security

The SoundStation2W™ is a highly secure voice communications solution. There are five factors that contribute to the robust security:

1. Unique pairing between console and base station.
2. WDCT and DECT digital spread spectrum technology provides secure transmission.
3. The frequency hopping WDCT and DECT implementation makes it even more difficult for voice signal to be intercepted.
4. 64 bit voice encryption between the base station and console. This adds yet another layer of security in order to provide utmost confidence in the SoundStation2W™ solution.
5. Aux Out recording is controlled from the console user interface.

Mobile Phone Mode

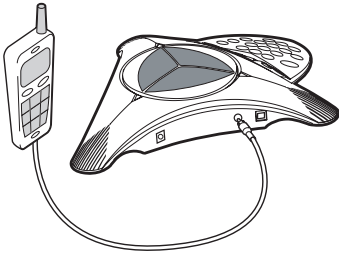

Mobile Phone Mode is an additional new mode of operation offered by the SoundStation 2W™. This feature enables you to combine the convenience of a mobile phone with the acoustics of a conference phone. For example, if you were in a call on your mobile telephone, you could connect your mobile telephone to the SoundStation2W™ and use its speaker and microphones to continue your conversation and include everyone in the room in the conversation. In this mode the call is travelling over the mobile phone network. The 2.4 GHz (WDCT) or 1.9 GHz (DECT) wireless link to the the basestation is not required.

Mobile Phone Mode provides unlimited flexibility to conference anywhere, even in environments where there are no analog lines or telephony infrastructure.

- ▶ Use the provided mobile phone connector cable to connect your mobile phone to the SoundStation2W™'s mobile phone input/output jack.
- ▶ The connector and the mobile phone cable will plug into a standard 2.5mm headset jack. A headset adaptor may be necessary to adapt your mobile phone to this connector. Adaptors are widely available at electronics stores and mobile phone outlets for universal hands-free kits.

- ▶ *The LCD on the console will display "Mobile Phone In" when it detects a connected mobile phone.*
- ▶ *The mobile phone interface is used for all dialing and call management functions during Mobile Phone Mode.*
- ▶ *Do not press the  on the console when using Mobile Phone Mode.*
- ▶ *No calls can be made via SoundStation2W™ while a mobile phone is connected to the SoundStation2W™.*
- ▶ *The Phone Book can be viewed during a call with a mobile phone. Calls may not be placed via the Phone Book while a mobile phone is connected.*
- ▶ *A mobile phone cannot join a call in progress on SoundStation2W™.*
- ▶ *Aux Out will be inactive during a call with a mobile phone.*
- ▶ *The base does not have to be powered up to use the SoundStation2W™ in this mode. The console may be used as an additional speaker and microphones.*
- ▶ *Some mobile phones will not be detected until a call is initiated by the mobile phone after it is connected to the SoundStation2W™.*
- ▶ *Voice quality may vary depending on the mobile phone connection and model.*
- ▶ *Be certain to drop the call at the mobile phone before disconnecting the cable from the SoundStation2W™.*

- ▶ Using your mobile phone, you can place calls and take advantage of the SoundStation2W™'s high quality speakers and microphones.



Using SoundStation2W™

- ▶ For best performance, charge the console for a full charging cycle (4 hours for BASIC, 8 hours for EX) prior to first use.

Placing a Call

SoundStation2W™ allows you to place a call over an analog line or through an analog terminal adapter (ATA). Several methods are available to initiate a call.

Direct Dial

1. To obtain dial tone, press the  key.
 2. Dial the desired number.
- ▶ To cancel the call, press the  key.

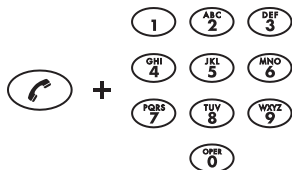

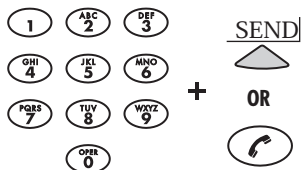

Indirect Dial

1. From the Ready screen, dial the desired number.
 2. Press the  key or the **SEND** soft key to make the call.
- ▶ If you make a mistake entering the telephone number, press the **<DEL** soft key.
 - ▶ Press the **CANCEL** soft key to cancel the call.



Answering a Call

Press the  key or any number key to answer an incoming call. Pressing the  button will override all other telephone activities. The three LEDs will blink green when the phone rings.

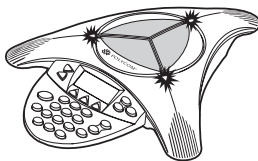

Answering a Second Call

If you are on a call when another call is received, you will hear a tone if your phone system is setup to support Call Waiting.

- ▶ Press the Conference button  to answer the incoming call. This first call will be automatically placed on hold.
- ▶ Switch back and forth between calls using the conference button .

Ending a Call

To end a call, press the  key.



Call Hold

When a call is on hold, you cannot hear your remote party, and they cannot hear you.

- ▶ To place a call on hold, press the **HOLD** soft key. The LEDs on the top of your SoundStation2W™ will blink red.
- ▶ To resume a call, press the **RESUME** soft key.

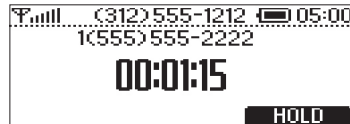

Call Mute

When a call is muted, you can hear the remote party, but they cannot hear you.

- ▶ To mute a call, press the mute button . The LEDs on the top of your SoundStation2W™ will glow red when your call is muted.
- ▶ To release mute, press the mute button again.

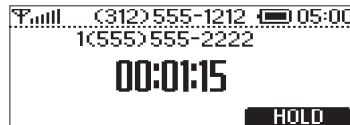

Call Timer

Call progress on an active call is monitored through a local call timer. This is visible within the active call window on the display.

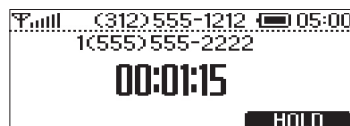

Redial

SoundStation2W™ stores the number that was last dialed. This number can be recalled using the **REDIAL** soft key.

- ▶ Press the **REDIAL** soft key. The last number called will be displayed and dialed.

OR

- ▶ Press the  key and then the **REDIAL** soft key. The last number called will be displayed and dialed.

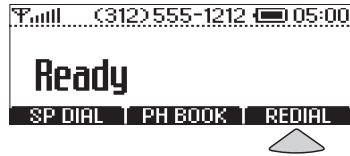

Speed Dial a Number

You can speed dial any entry in your Phone Book, in either of these ways:

Speed Dial Number First

1. Enter the 1- or 2-digit Speed Dial number.
2. Press the Phone button or the **SEND** soft key.

If a Speed Dial entry does not exist, a Not Assigned notice will appear. You can enter a new Speed Dial number or press the **CANCEL** soft key to leave the Speed Dial Menu.

Soft Key First

When the **SP DIAL** soft key is available:

1. Press the **SP DIAL** soft key.
2. Enter the 1- or 2-digit Speed Dial number (if you enter one digit, wait through the brief delay).

▶ For 1-digit numbers, you do not have to dial a leading 0. For example, for 02, you can also press 2.
▶ To create Phone Book entries and assign Speed Dial numbers, see "Adding an entry" on page 20.

Dialing using the Phone Book

Entries in the Phone Book can be automatically dialed.

1. Choose the entry you want to dial. (See “Quick selection in a list” on page 17.)
2. Press the **DIAL** soft key. You will see and hear the call being dialed.

► You can also access the **DIAL** soft key after selecting an entry with the **Select** button.

Ringer Volume Adjustment

When the SoundStation2W™ is in Ready state or on hook, press the Volume buttons to adjust the ringer volume.

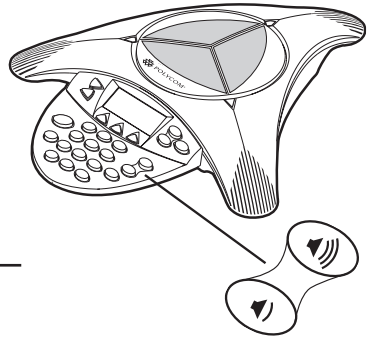

Dial Tone Volume Adjustment

When the SoundStation2W™ is off hook, press the Volume buttons to adjust the dial tone volume.

Speaker Volume Adjustment

During an active call, press the Volume buttons to adjust the speaker volume.

Display Contrast Adjustment

1. Press the Menu button and choose Settings and press the Select button.
2. Cycle through the options using the Scrolling buttons and choose Contrast, and then press the Select button.
3. Press the Scrolling buttons or the + and - soft keys to adjust the display contrast.
4. Press the **SAVE** soft key or Select button to apply the selected contrast setting.
 - Press the Exit button to cancel this change.

► **SETTINGS**
THIS PHONE
BRIDGE SETUP
ADMIN SETUP

CONTRAST

■ ■ ■ □ □ □ □

- + SAVE

Ringer Type Selection

1. Press the Menu button and choose Settings and press the Select button.
2. Cycle through the options using the Scrolling buttons and choose Ringer Type, and then press the Select button.
3. Sample the ring types by pressing the Scrolling buttons or the <- and -> soft keys.
4. Press the **SAVE** soft key or Select button to apply the selected ringer setting.

- ▶ Press the Exit button to cancel this change.



Backlight Adjustment

The SoundStation2W™'s display lights up when any button on the keypad is pressed, or on an incoming call.

To turn the back light on or off:

1. Press the Menu button and choose Settings and press the Select button.
2. Cycle through the options using the Scrolling buttons and choose Back Light, and then press the Select button.
 - ▶ The current status of the back light will be displayed.
3. Press the **ON** or **OFF** soft key or cycle through OFF and ON by pressing the Scrolling buttons.
4. Press the **SAVE** soft key or Select button to apply the selected back-light setting or the Exit button to cancel this change.



Language

SoundStation2W™ allows you to select your preferred language for the phone to use when displaying information.

To change the language setting:

1. Press the Menu button and choose Settings.
2. Cycle through the options using the Scrolling buttons and choose Language, and then press the Select button.
3. Cycle through the available languages by pressing the Scrolling buttons or the <— and —> soft keys.
4. Press the **SAVE** soft key or Select button to apply the selected language setting or the Exit button to cancel this change.

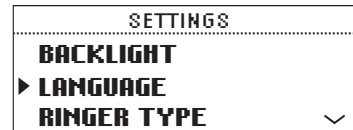
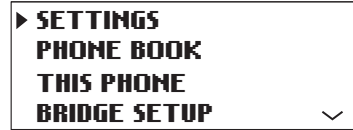





Conferencing - using the button

If your telephone system supports multi-party call conferencing, then you can establish multi-party calls with your SoundStation2W™.

- Check with your System Administrator to determine the number of parties that can be conferenced together.
- Your System Administrator may need to activate multi-party conferencing features or provide you with instructions specific to your telephone system.

Adding a call

1. While on an active call, press the Conference button . The first call is automatically placed on hold.
 2. Dial the number you wish to call. You may use the Redial or Direct Dial method.
 3. Press the Conference button  or **JOIN** soft key to join the second call. To drop the second call, press the Conference button  again.
- OR
1. Press the **HOLD** soft key to place the first call on hold.
 2. Press the Conference button  and enter the number you wish to call. You may use the Redial or Direct Dial method.

Bridge Soft Key

You may program the telephone number of your preferred conferencing bridge vendor into the SoundStation2W™ so that it is immediately available.

▶ The **SPEED DIAL** soft key will not display when the bridge number is configured.

Programming the Bridge number

1. Press the Menu button, choose Bridge Setup using the Scrolling buttons, and press the Select button.
2. Choose Enter Phone Number and press the Select button and then enter the bridge number using the dial pad. Enter any necessary prefix such as 9 and/or 1.
 - ▶ If you make a mistake entering the number, use the <DEL soft key to correct the error.
3. Press the **SAVE** soft key or **CANCEL** soft key if you wish to cancel the procedure.



Editing the Bridge soft key

1. Press the Menu button, choose Bridge Setup using the Scrolling buttons, and press the Select button.
2. Choose **EDIT** soft key, press the Select button and enter the new soft key label using the dial pad. The first six characters will display.
 - ▶ If you make a mistake entering the soft key label, use the <DEL soft key to correct the error.
3. Press the **SAVE** soft key or **CANCEL** soft key if you wish to cancel the procedure.



Placing a call using the Bridge soft key

1. Press the **BRIDGE** soft key.
2. The programmed number is automatically dialed and a call is placed to your preferred bridge vendor.

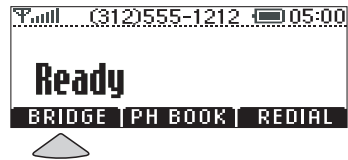

Phone Book

You can use the Phone Book to store a local directory of 25 contacts. You can add, edit, delete, dial, or search any contact in this list through just a few key strokes.

Selecting the **PH BOOK** soft key displays the Phone Book list sorted by names. This list may be sorted by Name, Company, or Speed Dial.

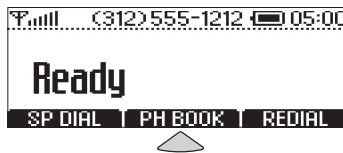

Quick selection in a list:

Name or Company list: Press a numeric key that corresponds with the letter that the name or company name begins with. For example, pressing 3 repeatedly will provide you with names that begin with D, E, F, and 3.

Speed Dial list: Press a numeric key to select the corresponding entry. For example, pressing 2 would select entry 02, and pressing 23 would select entry 23.



Adding an entry

1. Press the **PH BOOK** soft key and then the **NEW** soft key.
2. Enter information in the *Name*, *Ph#* (telephone number including any prefixes, such as 9 and/or 1), and *Co* (company) field using the alphanumeric keys on the dial pad. You can move between fields using the Scrolling buttons.
3. Press the **SAVE** soft key. You can accept the next available speed dial number assigned to your new entry or you can choose your own speed dial number by using the Scrolling buttons or the dial pad.
4. Press the **OK** soft key to save or the **BACK** soft key to edit the phone book entry.



Name: |
PH#:
CO:
CANCEL



Name: **Charles** |
PH#:
CO:
<DEL **SPACE** **CANCEL**



Name: **Charles White**
PH#: **5555559876**
CO:
<DEL **SPACE** **SAVE**



Charles White
Speed Dial #: 24
BACK **OK**

Editing an entry

1. Choose the entry you wish to edit and press the Select button.
2. Press the **CHANGE** soft key. Using the Scrolling buttons, select the field you wish to edit.
3. Using the alphanumeric keys on the dial pad, make changes.
4. Press the **SAVE** soft key. You can accept the current speed dial number assigned to the entry or you can choose another speed dial number by using the Scrolling buttons or the dial pad.
5. Press the **OK** soft key to save or the **BACK** soft key to edit the phone book entry.



23 Charles White
5555559876
CHANGE **REMOVE** **DIAL**

Deleting an entry

1. Choose the entry you wish to delete and press the Select button.
2. Press the **REMOVE** soft key. Press the **OK** soft key to remove or the **CANCEL** soft key to leave the menu without removing.

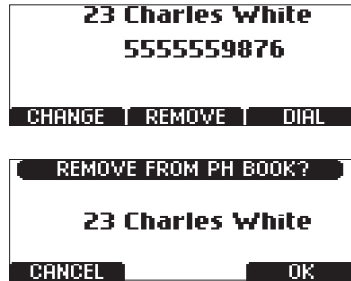

View System Information

This feature displays the following information about the SoundStation2W™: Location and Number, System Information, and Registration Information. With this feature you can easily identify the home room location for the phone.

Location and Number

1. Press the Menu button and choose This Phone and press the Select button.
2. Cycle through the options using the Scrolling buttons and choose Location and Number, and then press the Select button.

System Information

1. Press the Menu button and choose This Phone and press the Select button.
2. Cycle through the options using the Scrolling buttons and choose System Information, and then press the Select button.

Registration Information

1. Press the Menu button and choose This Phone and press the Select button.
2. Cycle through the options using the Scrolling buttons and choose Registration Information, and then press the Select button.

Standby Mode

The phone has an automatic power save function to extend battery operated usage. The product will switch into Standby within one minute of being in an idle inactive state. The console will not go into Standby if there is an active call, even if there are pauses in the conversation.

If the console is registered to the base station, and the phone goes into Standby mode, the LCD will display a “READY” message.

The console will switch into Standby mode even when it is not registered to the base station. In the case where the console isn't registered to the base station and goes into Standby, the LCD will display a “NO SIGNAL” message.

Any key press will “wake” the phone up. All features of the phones are instantly available by pressing the normal key sequences. Incoming calls and paging also functions normally while the phone is in Standby, and will switch the phone to active use mode.

▶ *Standby mode saves power but is not an “Off” function. If you want to fully turn the unit off, unplug the battery.*

▶ *While in Standby mode, the LCD display will still show estimated remaining talk time. Talk time is shown numerically in hours to the right of the battery icon.*

▶ *The console will switch into Standby, even if it is not registered to the base station. For example, if you travel with the phone to a remote location without the base station, the console will switch into Standby to conserve power.*

▶ *The console will automatically re-register to its base station from Standby mode, if it is within range and the base station is powered.*

▶ *In some cases, the phone will not go into Standby mode when a mobile phone is plugged in, even if the mobile phone is not in an active call. In these cases the LCD message will continue to say “Mobile Phone In”. Either turn off the mobile phone, or unplug it from the console to enable Standby.*

▶ *The phone will not go into Standby while charging.*

Charging

SoundStation2W™ operates on a rechargeable lithium ion battery. The battery needs to be recharged periodically. Use the supplied charger to recharge the battery while it is installed in the console. In similar fashion to a laptop PC or a mobile phone, the SoundStation2W™ can be used or continue operation while being charged. The battery cannot be recharged outside the console.

Charging State

The SoundStation2W™'s display will indicate when the battery is charging by animating the battery icon.

Low Power

The SoundStation2W™'s display will indicate when battery charge is low. The low battery warning will begin when the remaining talk time is approximately 20% or less of the full charge capacity. The warning will be triggered when a user goes back on-hook after completing a call. This ensures that the low power warning is seen by a user. In addition to a visual message on the console LCD which will read, "**Low Battery, Please Charge,**" you will hear an audible beeping alert.

Typical talk time and standby time are shown here:

	2 cell battery	4 cell battery
Charge Time	4 hours	8 hours
Talk Time	12 hours	24 hours
Standby Time	80 hours	160 hours

Battery icon displayed on LCD.

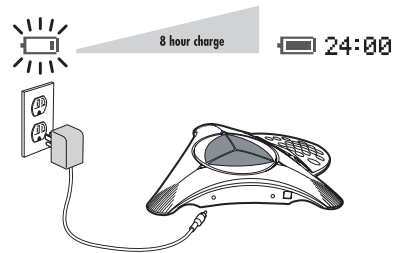

- ▶ *Optimum battery performance may be achieved only after the battery is conditioned. The battery will have to go through four to five charge and discharge cycles before reaching optimum performance.*
- ▶ *Talk time is measured for natural conversation at optimum volume levels.*

Auxiliary Audio Output

SoundStation2W™ allows the speaker output to be routed to an external recording device. The external recording device should be connected to the base station.

1. Connect an external recording device, such as a cassette tape recorder, via the auxiliary jack on the base station.
 2. Press the Menu button on the phone console, choose Settings and press the Select buttons.
 3. Choose Aux Audio Out and press the Select button. Press ON or OFF or cycle through the options using the Scrolling button. Press the **SAVE** soft key or Select button to save the setting
- ▶ Aux Audio Out will return to the *Off* setting when the call is terminated.

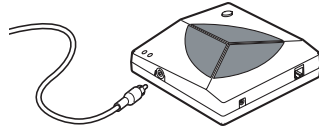

▶ *The Aux Audio Out does not support external loudspeaker systems.*

Paging the Console

You can locate a misplaced console by using the paging feature. When paging, the console beeps. This will allow you to locate the console.

1. Press the Page button on the base station to locate the SoundStation2W™ console.
2. The console will play a sound to indicate its location. The console will continue to beep until any key on the console is pressed or until the Page button on the base is pressed.



LCD Message Summary

The following messages are displayed on the console LCD to represent various usage conditions.

LCD Message	What it means:	What you will see:
Ready	Phone is in idle state and ready to make calls.	Idle screen.
No Signal	Signal strength is too weak to carry a call.	Antenna icon will show zero bars.
Call Ended	The call has been dropped.	"Call Ended" with elapsed time indicated.
Mobile Phone In	A mobile phone is plugged in to the mobile phone jack OR a mobile phone call has been initiated.	"Mobile Phone In"
Searching for Signal	Attempting to contact the base station to establish a connection.	"Searching for Signal"
Enter Number	Enter the number you wish to dial.	Digits of the number you are dialing.
Charging	A charger is plugged in and battery is recharging.	"Charging"
Base Paging	Page button on base was pressed to locate the console.	Base paging. Press any key to stop beeping.
Battery Low	The charge in the battery has depleted. A recharge is required to continue reliable operation of your SoundStation2W™.	The remaining talk time and an audible warning tone.
Incoming Call	Phone received an incoming call.	"Incoming Call"

Troubleshooting

No Signal

“No Signal” is displayed when the console loses contact with the base. Verify the following:

- ▶ Check that the base station is powered up.
- ▶ Make sure that the console is not out of the allowed range (150 feet).
- ▶ Move the console to a location where there are fewer obstructions or walls between console and base station.
- ▶ If the console and base station are separated by multiple brick walls, this will reduce the available range between the base and console.

No Dial Tone

The base station must be plugged into an analog telephone jack. If the dial tone is not heard, verify the following:

- ▶ Check that the base is powered on.
- ▶ Check that the console is operational.
- ▶ Check that the base is connected to an analog telephone (POTS) line.

Does Not Ring

- ▶ Check that the ringer is not turned off. See “Ringer Type Selection”, page 15.
- ▶ Try increasing the ringer volume.

Flickering LCD

If your screen appears to flicker, it may be because you are using a certain type of florescent light-

ing in your building. Move the SoundStation2W™ away from the lights.

Keypad Input Doesn't Register

This could happen if you enter information too quickly. Press the alphanumeric buttons more slowly.

Muffled or “in a well” Reception

This is caused by highly reverberant rooms and people speaking too far from the microphone.

- ▶ Speak closer to the console so that the microphones pick up your speech more accurately.
- ▶ Add more sound absorbency to the room.

Short Silences, Echoes, or Clipped Speech

- ▶ Do not move the SoundStation2W™ console while it is in use.
- ▶ Keep your hands away from the console during calls.
- ▶ To avoid excessive noise around SoundStation2W™, move computers, projectors, papers, cups, and other noise-producers away from the console.
- ▶ At the beginning of each call, let someone at each location speak in turn for a few moments to enable SoundStation2W™ to adapt to its environment.
- ▶ The other parties may be using non-Polycom equipment which may cause strange audio.
- ▶ Try calling again; a different line may provide a better connection.

Physical Damage

- ▶ If physical damage is severe enough that the internal parts become visible, disconnect the SoundStation2W™ immediately.
- ▶ Do not reconnect to the telephone network until the SoundStation2W™ has been repaired.

For Best Performance

Your SoundStation2W™ performs optimally when you follow these guidelines:

- ▶ Position the SoundStation2W™ in the center of the conference table or desk.
- ▶ The SoundStation2W™ works best in rooms that are 10'x20' or smaller.
- ▶ Do not move the SoundStation2W™ during a call.
- ▶ Do not shuffle papers near the SoundStation2W™.
- ▶ If using extended microphones, extend the cables to their full length and point their microphones away from the console.
- ▶ Speak at a normal conversation level, and direct your voice towards the SoundStation2W™, or towards the extended microphone.
- ▶ Unplug all cords from the base and console before cleaning the SoundStation2W™. Do not use liquid cleaners or aerosol cleaners. Use a damp, soft cloth for cleaning.

Administrator Guide



Administrative Setup - Overview

The Administrative Setup menu consists of the following options. If desired, you can set a passcode to access the administrative options on the SoundStation2W™. There will not be any passcode required when you first use the phone.

Location:		
1	Location Name	Enter a name for the SoundStation2W™'s location, such as "Conference Room B".
2	This Phone #	Enter the SoundStation2W™'s telephone number.
Phone System:		
1	Caller ID	Turn Caller ID on or off (if available).
Passcode:		
1	Set a passcode if required.	
Diagnostics:		
1	Mic Test	View the sample level received by each microphone.
2	Console Speaker Test	Select acoustic test signals to drive through the SoundStation2W™'s speakers.
3	Restore Defaults	Reset all custom settings and data entries. Restores original default settings.
Software:		
1	Upgrade Software	Allows upgrade of SoundStation2W™ operational software to new releases.

Passcode

When you select Passcode from the Admin Setup menu, the screen will display whether or not a passcode is currently assigned.

Assign a passcode:

1. Press the Menu button, choose Admin Setup using the Scrolling buttons, and press the Select button. Choose Passcode using the Scrolling buttons, and press the Select button.
2. Press the **ASSIGN** soft key and enter a three-digit password. If you make an error, press the **<DEL** soft key to erase the error.
3. Press the **SAVE** soft key. You may press the **CANCEL** soft key or the Exit button if you choose not to save the passcode.

► Record the passcode. If the passcode is forgotten, contact Polycom Support at <http://esupport.polycom.com>.

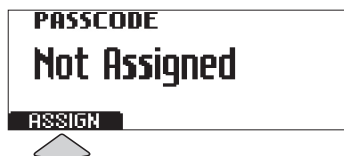
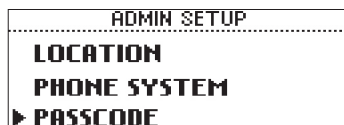

Remove a passcode:

Removing the passcode removes the requirement for an access passcode for the Admin Setup menu.

1. From the Admin Setup menu, choose Passcode using the Scrolling buttons and press the Select button.
2. Press the **REMOVE** soft key, enter the current passcode, and press the **ENTER** soft key. If you decide not to remove the password, press the **CANCEL** soft key or the Exit button.
 - If you enter an incorrect password, you will be notified to try again.
 - If you make an error, press the **<DEL** soft key to erase the error.

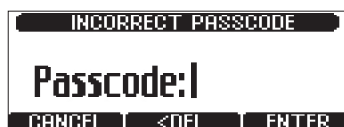

Change the passcode:

1. From the Admin Setup menu, choose Passcode using the Scrolling buttons and press the Select button.
2. Press the **CHANGE** soft key, enter the current passcode, and press the **ENTER** soft key. If you decide not to change the password, press the **CANCEL** soft key or the Exit button.
 - ▶ If you enter an incorrect password, you will be notified to try again.
 - ▶ If you make an error, press the **<DEL** soft key to erase the error.
3. You will be prompted to enter a new passcode. Enter a new passcode and press the **SAVE** soft key. You may press the **CANCEL** soft key or the Exit button if you choose not to save the passcode.
 - ▶ Record the passcode. If the passcode is forgotten, contact Polycom Support at <http://esupport.polycom.com>.



Location Information

You can assign a location name, such as “Conference Room B” and the telephone number associated with your SoundStation2W™. By assigning a location name you will easily be able to return the phone to its “home room” location or determine the location of the matching base station.

Assigning a location name:

1. Press the Menu button, choose Admin Setup and press the Select button, enter passcode (if required) and press the **ENTER** soft key. Choose Location using the Scrolling buttons, and press the Select button.



2. Choose Location Name using the Scrolling buttons, and press the Select button. Enter a location name using the dial pad. This name will be displayed when “Location Name and Number” submenu of “This Phone” menu is selected from the main menu.
 - ▶ If you make an error, press the <DEL soft key to erase the error.
3. Press the **SAVE** soft key or the Select button to save your entry. You may press the Exit button to cancel your entry.



Assigning a telephone number:

1. Press the Menu button, choose Admin Setup and press the Select button, enter passcode (if required) and press the **ENTER** soft key. Choose Location using the Scrolling buttons, and press the Select button.
2. Choose This Phone # using the Scrolling buttons, and press the Select button. Enter the SoundStation2W™'s telephone number.
 - ▶ If you make an error, press the <DEL soft key to erase the error.
3. Press the **SAVE** soft key or the Select button to save your entry. You may press the Exit button to cancel your entry.



Phone System

Caller ID*

You can turn Caller ID on or off. By default, Caller ID is on.

1. Press the Menu button, choose Admin Setup and press the Select button, enter passcode (if required) and press the **ENTER** soft key. Choose Phone System using the Scrolling buttons, and press the Select button.
2. Choose Caller ID using the Scrolling buttons, and press the Select button. Press the **ON** or **OFF** soft key or cycle through the options using the Scrolling buttons.
3. Press the **SAVE** soft key or the Select button to save your entry. You may press the Exit button to cancel your entry.

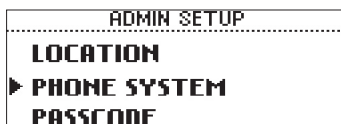

**Caller ID is a subscription service. Check with your local telephone service provider to determine if this service is available in your area.*

Audible Alerts

You can turn the Low Battery and Signal Strength audible alerts on or off. By default, the Low Battery audible alert will be on, but the Signal Strength audible alert will be off.

1. Press the Menu button, choose Admin Setup and press the Select button, enter passcode (if required) and press the **ENTER** soft key. Choose Phone System using the Scrolling buttons, and press the Select button.
2. Choose Audible Alerts using the Scrolling buttons, and press the Select button. Choose either Low Battery or Signal Strength using the Scrolling buttons, and press the Select button. Press the **ON** or **OFF** soft key or cycle through the options using the Scrolling buttons.
3. Press the **SAVE** soft key or the Select button to save your entry. You may press the Exit button to cancel your entry.

Flash Timing

You can adjust the timing of the Flash delay to 75, 100, 300, or 600 milliseconds.

1. Press the Menu button, choose Admin Setup and press the Select button, enter the passcode (if required) and press the **ENTER** soft key.
2. Choose Phone System followed by Flash Timing from the available options and press the Select button.
3. Use the <- and -> soft keys to step through the available Flash Timing options.
4. Press the **SAVE** soft key to save changes. You may press the Exit button to cancel your selection.
5. After about 15 seconds you should hear the tone, and you should see **READY** appear on the console's LCD screen. This indicates that the console and base station have reconnected. The new settings will now be active.

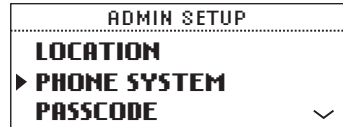

If you change the Flash Timing setting while you are on a call, the new setting will become stored as soon as the user goes back onhook after the call.

Diagnostics

Mic (Microphone) Test

You may test the SoundStation2W™'s microphones to ensure that they are working optimally.

► If testing microphone's meter indicates that it is receiving an atypically low or high sample, despite appropriately controlled input, contact Polycom Technical Support.

1. Press the Menu button, choose Admin Setup and press the Select button, enter passcode (if required) and press the **ENTER** soft key. Choose Diagnostics using the Scrolling buttons, and press the Select button.
2. Choose Mic Test using the Scrolling buttons, and press the Select button. The microphones are numbered according to the diagram.
3. Choose any microphone using the Scrolling buttons, and press the Select button.
 - The testing microphone's LED will glow red.
 - The testing microphone will begin sampling at a 1 Hertz rate, 50% duty cycle.
 - The display will show a meter that modulates according to the relative sample received by the testing microphone.

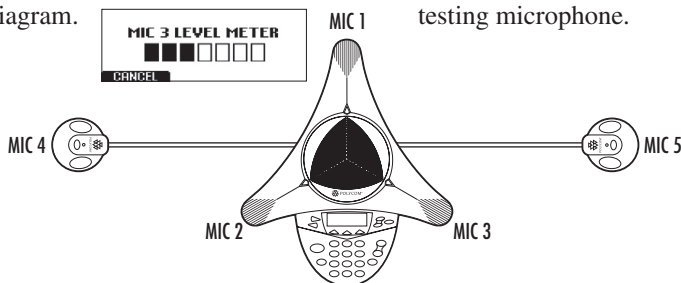

Console SPKR (Speaker) Test

You can select an acoustic test signal to drive through the SoundStation2W™'s speaker for speaker testing and to sample the room acoustics.

1. Press the Menu button, choose Admin Setup and press the Select button, enter passcode (if required) and press the **ENTER** soft key. Choose Diagnostics using the Scrolling buttons, and press the Select button.
2. Choose Console Speaker Test using the Scrolling buttons, and press the Select button. Choose the desired signal using the Scrolling buttons
 - Sine Sweep is a test signal consisting of a 100 Hertz to 3,500 Hertz sine wave whose frequency is swept according to a linear progression of frequency as a function of time, or $(t)=A*\sin(kt)$.
 - One kilohertz Tone is a constant tone generated at exactly 1,000 Hertz.

► White Noise is a signal whose energy is distributed uniformly among all frequencies within a band of interest, which for the SoundStation2W™

3. Press the Select button to activate the signal.

Restore Defaults

Restoring the defaults will irretrievably remove all settings and data that have been entered since the SoundStation2W™ was first installed.

1. Press the Menu button, choose Admin Setup and press the Select button, enter passcode (if required) and press the **ENTER** soft key. Choose Diagnostics using the Scrolling buttons, and press the Select button.
 2. Choose Restore Defaults using the Scrolling buttons, and press the Select button. Press the **OK** soft key if you wish to restore defaults or the **CANCEL** soft key or the Exit button to return to the Diagnostics submenu.
- Phone Book entries and Speed Dial numbers are not lost when restoring all defaults.

Software Upgrade

Please refer to the SoundStation2W™ section of the Polycom website at www.polycom.com for information on software upgrades.

Specifications and Warranty Information



Limited Warranty and Limitation of Liability

Limited Warranty

Polycom warrants to the end user (“Customer”) that this product will be free from defects in workmanship and materials, under normal use and service, for one year from the date of purchase from Polycom or its authorized reseller.

Polycom’s sole obligation under this express warranty shall be, at Polycom’s option and expense, to repair the defective product or part, deliver to Customer an equivalent product or part to replace the defective item, or if neither of the two foregoing options is reasonably available, Polycom may, in its sole discretion, refund to Customer the purchase price paid for the defective product. All products that are replaced will become the property of Polycom. Replacement products or parts may be new or reconditioned. Polycom warrants any replaced or repaired product or part for ninety (90) days from shipment, or the remainder of the initial warranty period, whichever is longer.

Products returned to Polycom must be sent prepaid and packaged appropriately for safe shipment, and it is recommended that they be insured or sent by a method that provides for tracking of the package. Responsibility for loss or damage does not transfer to Polycom until the returned item is received by Polycom. The repaired or

replaced item will be shipped to Customer, at Polycom’s expense, not later than thirty (30) days after Polycom receives the defective product, and Polycom will retain risk of loss or damage until the item is delivered to Customer.

LIMITATION OF LIABILITY. TO THE FULL EXTENT ALLOWED BY LAW, POLYCOM EXCLUDES FOR ITSELF AND ITS SUPPLIERS ANY LIABILITY, WHETHER BASED IN CONTRACT OR TORT (INCLUDING NEGLIGENCE), FOR INCIDENTAL, CONSEQUENTIAL, INDIRECT, SPECIAL, OR PUNITIVE DAMAGES OF ANY KIND, OR FOR LOSS OF REVENUE OR PROFITS, LOSS OF BUSINESS, LOSS OF INFORMATION OR DATA, OR OTHER FINANCIAL LOSS ARISING OUT OF OR IN CONNECTION WITH THE SALE, INSTALLATION, MAINTENANCE, USE, PERFORMANCE, FAILURE, OR INTERRUPTION OF ITS PRODUCTS, EVEN IF POLYCOM OR ITS AUTHORIZED RESELLER HAS BEEN ADVISED OF THE POSSIBILITY OF SUCH DAMAGES, AND LIMITS ITS LIABILITY TO REPAIR, REPLACEMENT, OR REFUND OF THE PURCHASE PRICE PAID, AT POLYCOM’S OPTION. THIS DISCLAIMER OF LIABILITY FOR DAMAGES WILL NOT BE AFFECTED IF ANY REMEDY PROVIDED HEREIN SHALL FAIL OF ITS ESSENTIAL PURPOSE.

Exclusions

Polycom will not be liable under this limited warranty if its testing and examination disclose that the alleged defect or malfunction in the product does not exist or results from:

- ▶ Failure to follow Polycom’s installation, operation, or maintenance instructions;
- ▶ Unauthorized product modification or alteration;

- ▶ Unauthorized use of common carrier communication services accessed through the product;
- ▶ Abuse, misuse, negligent acts or omissions of Customer and persons under Customer’s control; or
- ▶ Acts of third parties, acts of God, accident, fire, lightning, power surges or outages, or other hazards.

WARRANTY EXCLUSIVE. IF A POLYCOM PRODUCT DOES NOT OPERATE AS WARRANTED ABOVE, CUSTOMER'S SOLE REMEDY FOR BREACH OF THAT WARRANTY SHALL BE REPAIR, REPLACEMENT, OR REFUND OF THE PURCHASE PRICES PAID, AT POLYCOM'S OPTION. TO THE FULL EXTENT ALLOWED BY LAW, THE FOREGOING WARRANTIES AND REMEDIES ARE EXCLUSIVE AND ARE IN LIEU OF ALL OTHER WARRANTIES, TERMS OR CONDITIONS, EXPRESS OR IMPLIED, EITHER IN FACT OR BY OPERATION OF

LAW, STATUTORY OR OTHERWISE, INCLUDING WARRANTIES, TERMS OR CONDITIONS OF MERCHANTABILITY, FITNESS FOR A PARTICULAR PURPOSE, SATISFACTORY QUALITY, CORRESPONDENCE WITH DESCRIPTION, AND NON-INFRINGEMENT, ALL OF WHICH ARE EXPRESSLY DISCLAIMED. POLYCOM NEITHER ASSUMES NOR AUTHORIZES ANY OTHER PERSON TO ASSUME FOR IT ANY OTHER LIABILITY IN CONNECTION WITH THE SALE, INSTALLATION, MAINTENANCE OR USE OF ITS PRODUCTS.

Service Agreements

If you purchased your product from a Polycom Authorized Reseller, contact the Authorized Reseller for information about service agreements applicable to your product. For technical

support contact Polycom Support at <http://esupport.polycom.com>.

Disclaimer

Some countries, states, or provinces do not allow the exclusion or limitation of implied warranties or the limitation of incidental or consequential damages for certain products supplied to consumers, or the limitation of liability for personal injury, so the above limitations and exclusions may be limited

in their application to you. When the implied warranties are not allowed to be excluded in their entirety, they will be limited to the duration of the applicable written warranty. This warranty gives you specific legal rights which may vary depending on local law.

Governing Laws

This Limited Warranty and Limitation of Liability shall be governed by the laws of the State of California, USA, and by the laws of the United States, excluding their conflicts of laws principles. The United Nations Conven-

tion on Contracts for the International Sale of Goods is hereby excluded in its entirety from application to this Limited Warranty and Limitation of Liability.

FCC Rules

This device complies with part 15 of the FCC Rules. Operation is subject to the following two conditions:

- (1) This device may not cause harmful interference, and
- (2) This device must accept any interference received, including interference that may cause undesired operation.

NOTE: This equipment has been tested and found to comply with the limits for a Class B digital device, pursuant to part 15 of the FCC Rules. These limits are designed to provide reasonable protection against harmful interference in a residential installation. This equipment generates, uses and can radiate radio frequency energy and, if not installed and used in accordance with the instructions, may cause harmful interference to radio communications. However, there is no guarantee that interference will not

occur in a particular installation. If this equipment does cause harmful interference to radio or television reception, which can be determined by turning the equipment off and on, the user is encouraged to try to correct the interference by one or more of the following measures:

- ▶ Reorient or relocate the receiving antenna.
- ▶ Increase the separation between the equipment and receiver.
- ▶ Connect the equipment into an outlet on a circuit different from that to which the receiver is connected.
- ▶ Consult the dealer or an experienced radio/TV technician for help.

In accordance with part 15 of the FCC rules, the user is cautioned that any changes or modifications not expressly approved by Polycom Inc. could void the user's authority to operate the equipment.

Canadian Department of Communications Notice

This Class [B] digital apparatus complies with Canadian ICES-003.

Cet appareil numérique de la classe [B] est conforme à la norme N M B-003 du Canada.

US Telephone Company Requirements

This equipment complies with part 68 of the FCC Rules. Please refer to the labeling on equipment for the following information:

- ▶ Registration Number
- ▶ Ringer Equivalence
- ▶ Grantee's Name

Notes:

- ▶ This registered equipment may not be used with party lines or coin lines.
- ▶ If trouble is experienced, the customer shall disconnect the registered equipment from the telephone line to determine if the registered equip-

- ▶ Model Number
- ▶ Serial Number and/or Date of Manufacture
- ▶ Country of Origin

If requested, this information must be provided to the telephone company.

ment is malfunctioning and that if the registered equipment is malfunctioning, the use of such equipment shall be discontinued until the problem has been corrected.

- ▶ If, in the unlikely event that this

equipment causes harm to the network, the telephone company will notify you in advance that temporary discontinuance of service may be required. However if advance notice is not practical, the telephone company will notify you as soon as possible. Also, you will be advised of your right to file a complaint with the FCC if you believe it necessary.

- ▶ The telephone company may make changes to its facilities, equipment, operations or procedures that could affect the operation of the equipment. If this happens, the telephone company will provide advance notice so you can make the necessary modifications to maintain uninterrupted service.

Ring Equivalency Number (REN)

The REN is used to determine the quantity of devices that may be connected to the telephone line. Excessive RENs on the telephone line may result in the devices not ringing in response to an incoming

call. Typically the sum of RENs should not exceed five (5.0). To be certain of the number of devices that may be connected to a line (as determined by the total RENs) contact the local telephone company.

Automatic Dialing

WHEN PROGRAMMING EMERGENCY NUMBERS AND/OR MAKING TEST CALLS TO EMERGENCY NUMBERS:

1. Remain on the line and briefly explain to the dispatcher the reason

for the call.

2. Perform such activities in the off-peak hours, such as early morning or late evening.

Telephone Company Connector

A FCC compliant telephone cord and modular plug is provided with this equipment. This equipment is designed to be connected to the telephone network

or premises wiring using a compatible modular jack that is Part 68 compliant. See the rest of these installation instructions for details.

Canadian Telephone Company Requirements

“NOTICE: The Industry Canada label identifies certified equipment. This certification means that the equipment meets telecommunications protective, operational and safety requirements as prescribed in the appropriate Terminal Equipment Technical Requirements document(s). The Department does not guarantee the equipment will operate to the user’s satisfaction.

Before installing this equipment, users should ensure that it is permissible to be

connected to the facilities of the local telecommunications company. The equipment must also be installed using an acceptable method of connection. The customer should be aware that compliance with the above conditions may not prevent degradation of service in some situations. Repairs to certified equipment should be coordinated by a representative designated by the supplier. Any repairs or alterations made by the user to this equipment, or equipment malfunctions,

may give the telecommunications company cause to request the user to disconnect the equipment.

Users should ensure for their own protection that the electrical ground connections of the power utility, telephone lines and internal metallic water pipe system, if present, are connected together. This precaution may be particularly important in rural areas.

Caution: Users should not attempt to make such connections themselves, but should contact the appropriate electric inspection authority, or electrician, as appropriate.”

“NOTICE: The Ringer Equivalence Number (REN) assigned to each relevant terminal device provides an indication of the maximum number of terminals allowed to be connected to a telephone interface. The termination on an interface may consist of any combination of devices subject only to the requirement that the sum of the Ringer Equivalence Numbers of all the devices does not exceed 5.”

The term “IC:” before the certification/ registration number signifies only that the Industry Canada technical specifications were met.

Exhibit J - Customer Information

This equipment complies with Part 68 of the FCC rules and the requirements adopted by the ACTA. On the exterior of the cabinet of this equipment is a label that contains, among other information, a product identifier in the format US: 2HWW402B-SS2W. If requested, this number must be provided to the telephone company.

- FCC Registration Number:
US: 2HWW402B-SS2W
- Ringer Equivalence Number (REN):0.25
- Facility Interface Code (FIC):02LS2
- Service Order Code (SOC): 9.0Y
- USOC Jack Type: RJ11W

A FCC compliant telephone cord and modular plug is provided with this equipment. This equipment is designed to be connected to the telephone network or premises wiring using a compatible modular jack that is Part 68 compliant. See Installation Instructions for details.

The REN is used to determine the quantity of devices that may be connected to the telephone line. Excessive RENs on the telephone line may result in the devices not ringing in response to an incoming call. Typically, the sum of RENs should not exceed five (5.0). To be certain of the

number of devices that may be connected to a line (as determined by the total RENs) contact the local telephone company. If this equipment SoundStation2W™ causes harm to the telephone network, the telephone company will notify you in advance that temporary discontinuance of service may be required. But if advance notice isn't practical, the telephone company will notify the customer as soon as possible. Also, you will be advised of your right to file a complaint with the FCC if you believe it is necessary.

The telephone company may make changes to its facilities, equipment, operations or procedures that could affect the operation of the equipment. If this happens, the telephone company will provide advance notice so you can make the necessary modifications to maintain uninterrupted service.

For technical support, contact Polycom Support at <http://esupport.polycom.com>. If the equipment is causing harm to the telephone network, the telephone company may request that you disconnect the equipment until the problem is resolved.

Connection to party line service is subject to state tariffs. (Contact the state public utility commission, public service commission or corporate commission for information.)

IMPORTANT: The antenna used for this transmitter must be installed to provide a separation distance of at least 20 centimeters from all persons and must not be co-located or operating in conjunction with any other antenna or transmitter.

CE Mark R and TTE Directive

This SoundStation2W has been marked with the CE mark. This mark indicates compliance with EEC Directives 89/336/EEC, 73/23/EEC 1999/5/EC. A full copy of the Declaration of Conformity can be obtained from Polycom Ltd, 270 Bath Road, Slough, Berkshire, SL1 4DX, UK.

Declaration of Conformity:

Hereby, Polycom Ltd. declares that this SoundStation2W is in compliance with the essential requirements and other relevant provisions of Directive 1999/5/EC.

Konformitetserklæring:

Hermed erklærer Polycom Ltd., at indestående SoundStation2W er i overensstemmelse med de grundlæggende krav og de relevante punkter i direktiv 1999/5/EF.

Konformitätserklärung:

Hiermit erklährt Polycom Ltd., dass der SoundStation2W die grundlegenden Anforderungen und sonstige maßgebliche Bestimmungen der Richtlinie 1999/5/EG erfüllt.

Δήλωση Συμμόρφωσης:

Δια του παρόντος, η εταιρεία Polycom Ltd. δηλώνει ότι η παρούσα συσκευή (δρομολογητής) SoundStation2W πληροί τις βασικές απαιτήσεις και άλλες βασικές προϋποθέσεις της Οδηγίας 1999/5/EK.

Vaatimustenmukaisuusvakuutus:

Polycom Ltd. vakuuttaa täten, että SoundStation2W on direktiivin 1999/5/EC keskeisten vaatimusten ja sen muiden tättä koskevien säännösten mukainen.

Déclaration de conformité :

Par la présente, Polycom Ltd. déclare que ce SoundStation2W est conforme aux conditions essentielles et à toute autre modalité pertinente de la Directive 1999/5/CE.

Dichiarazione di conformità:

Con la presente Polycom Ltd. dichiara che il SoundStation2W soddisfa i requisiti essenziali e le altre disposizioni pertinenti della direttiva 1999/5/CE.

Verklaring van overeenstemming:

Hierbij verklaart Polycom Ltd. dat diens SoundStation2W voldoet aan de basisvereisten en andere relevante voorwaarden van EG-richtlijn 1999/5/EG.

Declaração de Conformidade:

Através da presente, a Polycom Ltd. declara que este SoundStation2W se encontra em conformidade com os requisitos essenciais e outras disposições relevantes da Directiva 1999/5/CE.

Declaración de conformidad:

Por la presente declaración, Polycom Ltd. declara que este SoundStation2W cumple los requisitos esenciales y otras cláusulas importantes de la directiva 1999/5/CE.

Överensstämelseförklaring:

Polycom Ltd. förklarar härmed att denna SoundStation2W överensstämmer med de väsentliga kraven och övriga relevanta stadganden i direktiv 1999/5/EG.

Safety Notices

Installation Instructions

Installation must be performed in accordance with all relevant national wiring rules.

Plug Acts as Disconnect Device

The socket outlet to which this apparatus is connected must be installed near the equipment and must always be readily accessible.

Compliance

New Zealand Only:

1. This equipment shall not be set up to make automatic calls to the Telecom “111” Emergency Service.

2. This equipment may not provide for the effective hand-over of a call to another device connected to the same line.

3. IMPORTANT NOTICE:

► Under power failure conditions, this telephone may not operate. Please ensure that a separate telephone, not dependent on local power, is available for emergency use.

4. This product conforms to the DECT standard and uses a 128 bit User Authentication Key (UAK) for unique user security which provides greater than 3.4×10^{38} discrete codes.

5. GENERAL WARNING:

► The grant of a Telepermit for any item of terminal equipment indicates only that Telecom has accepted that the item complies with minimum conditions for connection to its network. It indicates no endorse-

ment of the product by Telecom, nor does it provide any sort of warranty. Above all, it provides no assurance that any item will work correctly in all respects with another item of Telepermitted equipment of a different make or model, nor does it imply that any product is compatible with all of Telecom’s network services.



For information, contact your reseller or go to:
www.polycom.com

Polycom WW Headquarters:

Polycom, Inc. Corporate Headquarters
4750 Willow Road
Pleasanton, CA 94588

Polycom®, SoundStation®, and the Polycom logo design are registered trademarks of Polycom, Inc. in the U.S. and various countries. SoundStation2W™ is a registered trademark of Polycom, Inc. ©2005 Polycom, Inc. All Rights Reserved.

3810-07875-001 Rev. B
Reorder PN 2151-07890-001