



Metrics ICS Driver Manual

HP4145

Metrics ICS

Version 3.8.0

© Copyright 1999-2007, Metrics Technology, Inc.

All rights reserved.

Table of Contents

The HP4145 Instrument Driver	2
Getting Started: Creating and Executing a Test Setup.....	2
Step 1: Cable the Hardware Connections	2
Step 2: Connect the HP4145 Instrument Driver	3
Step 3: Specify the GPIB Address	4
Step 4: Create the Test Setup	7
Step 4A: Specify the Test Setup Name.....	7
Step 4B: Select a Device Schematic Corresponding to the DUT	8
Step 4C: Designate the Source/DUT Connections	9
Step 4D: Specify the Source/Measure Configuration of Each Source	10
Step 5: Insert the DUT Into the Test Fixture	12
Step 6: Execute the Measurement.....	12
Step 7: View the Results	12
Step 8: Create a Plot of the Results.....	13
Step 9: Save the Results into a Project File	14
Source Unit Availability	15
The Source Unit Setup Dialogue Box.....	16
How to Display a Source Unit Setup Dialogue Box:.....	16
Force Conditions Controls	18
Mode	18
Type	26
Start.....	26
Stop	26
No. Points.....	26
Pts/Dec	27
No. Steps.....	27
Step Size.....	27
Value	27
Offset and Ratio	28
Compliance	28
Stimulus Controls	29
Measure Controls.....	30
Specifying Returned Data.....	30
Sweep Timing Controls	33
Mainframe Options	34
Integration Time.....	35
Single/Repeat Measure Mode	36
Report Compliance	37
Time Domain	38
Contrasting the HP4145 and ICS Time Domain Utilities.....	40
Setup Example	41
Collector Family	41

Collector Family Setup Conditions.....	42
Results.....	44

The HP4145 Instrument Driver

Getting Started: Creating and Executing a Test Setup

The Hewlett-Packard 4145A/B Semiconductor Parameter Analyzer is a high performance DC parametric measurement instrument used to measure the DC characteristics of microelectronic devices.

This section will walk you through the steps required to create and execute a test setup that measures diode turn-on voltage using the HP4145A/B Semiconductor Parameter Analyzer. This is simple measurement, but it will provide you with a general understanding of how Interactive Characterization Software(ICS) and the HP4145A/B are used to measure device characteristics.

Step 1: Cable the Hardware Connections

Cable all the necessary connections between the instrument sources and the test fixture. Connect the required jumpers between the test fixture sockets and personality board. The hardware connections configured in this step will be designated later in ICS' graphic workspace.

The test setup example presented in this section was executed using the HP4145A/B Semiconductor Parameter Analyzer along with the HP16058A Test Fixture and the HP16058-60005 Socket Module. A schematic of the hardware arrangement is shown below.

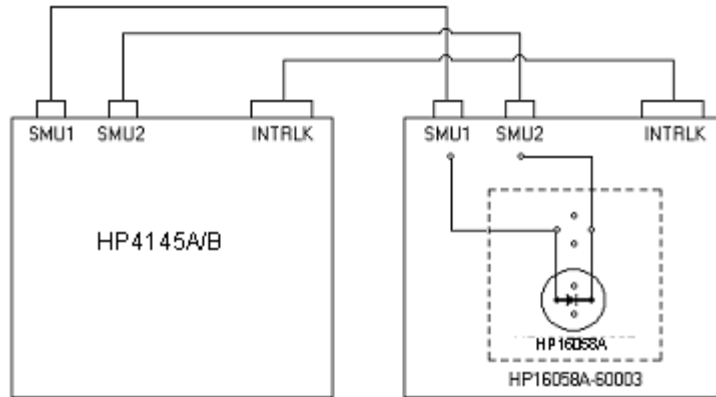
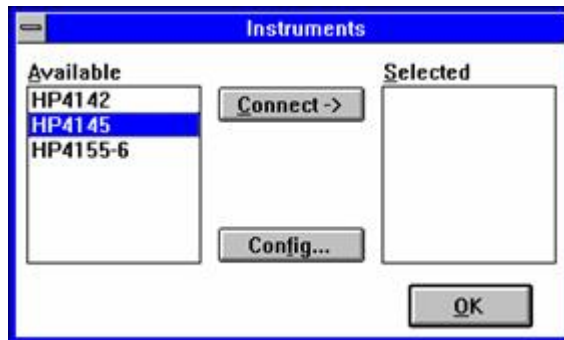

Figure 1: A Schematic of the Hardware Arrangement Used to Measure V_{ON} for an NP Diode.

Step 2: Connect the HP4145 Instrument Driver



The HP4145 Driver is connected using the Connect Instruments dialogue box accessed by choosing INSTRUMENTS/SELECT INSTRUMENT from the main menu bar.

How to Connect the HP4145 Driver:

1. Click the CONNECT INSTRUMENTS toolbar button or select INSTRUMENTS/SELECT INSTRUMENT from the ICS measurement mode menu bar. This will open the Connect Instruments dialogue box.
2. Highlight the HP4145 Driver in the AVAILABLE field.
3. Click the CONNECT button.

4. Your choice will be displayed in the SELECTED field.
5. Clicking the OK button would close the Connect Instruments dialogue box and restore control to the ICS desktop. Keep the Connect Instruments dialogue box displayed for now, because the next step requires you to click the Connect Instruments CONFIG button.

Step 3: Specify the GPIB Address

The HP4145 must be connected to your computer with the use of a standard IEEE-488 GPIB. The HP4145 Operation Manuals specify the use of an HP-IB interface in order to control the instrument remotely. The HP-IB designation is Hewlett-Packard's implementation of the IEEE-488 Standard Digital Interface for programmable instrumentation.

This section provides the basic information necessary to remotely control the HP4145. Please refer Chapter 3 of the HP4145A/B Operation Manual, to review the details of HP-IB interface control.

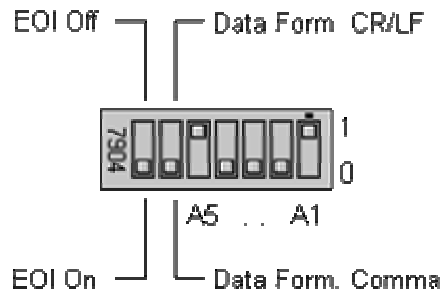

Before installing the GPIB cable, make certain that the HP-IB Control Switch located on the back panel of the instrument is configured correctly. The EOI Bit and Data Form Bit must be set to the OFF position. The remaining five bits are the Address Bits and can be configured to any binary value between 0 and 30. The HP-IB Control Switch is set to an address of 17 at the factory.

The HP4145 Configuration dialogue box is used to specify the GPIB address configured on the instrument's HP-IB Control Switch. The ID display is a static display field only and does not require any definition by the user.

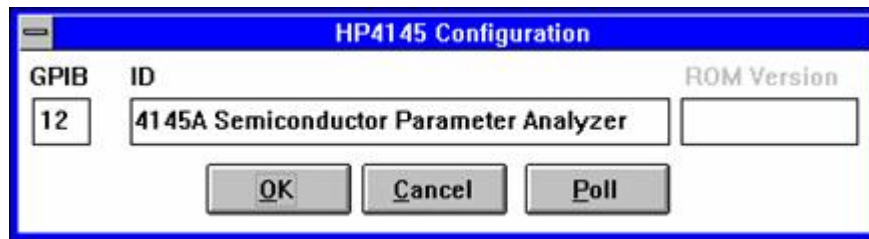

Figure 2: The Instrument GPIB Address is Designated in the HP4145 Configuration Dialogue Box.

How to Define the HP4145 GPIB Address:

1. Open the Connect Instruments dialogue box by selecting the CONNECT INSTRUMENTS toolbar button or by selecting INSTRUMENTS/SELECT INSTRUMENT from the measurement mode menu bar.
2. Make certain that the HP4145 Driver is connected. If not, highlight the HP4145 Driver in the AVAILABLE field and click the CONNECT button. Refer *Step 2: Connect the HP4145 Instrument Driver* for more information regarding the connection procedure.
3. Open the HP4145 Configuration dialogue box by clicking the CONFIG button at the bottom of the Connect Instruments dialogue box.
4. Enter the HP4145 GPIB address in the GPIB field. The GPIB address is determined by evaluating the position of the five binary address bits on the HP-IB Control Switch located on the back panel of the instrument. The HP-IB Control Switch specifies a binary address between 0 and 30. The HP4145 leaves the factory with HP-IB Control Switch set to an address of 17. If you wish to change the GPIB setting, please refer to Chapter 3 of the HP4145A/B Operation Manual.
5. Click the OK button located at the bottom of the dialogue box. This will close the Configuration dialogue box. Click the OK button in the upper right-hand corner of the Connect Instruments dialogue box to restore control to the ICS desktop.

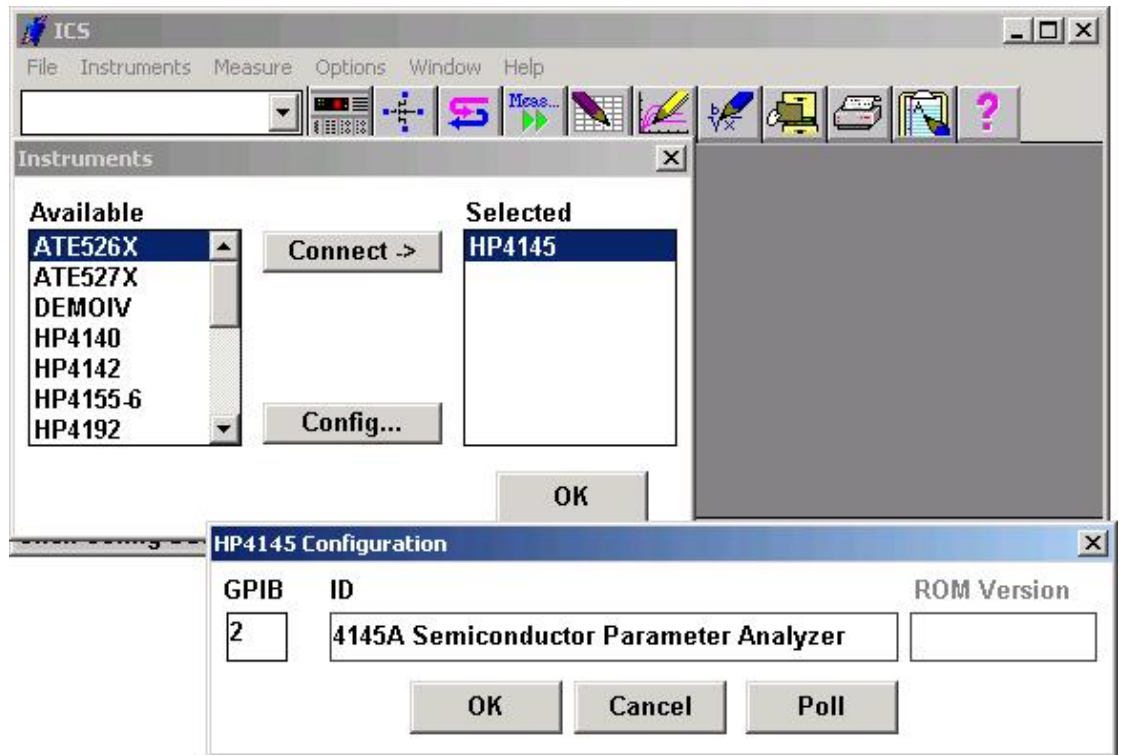
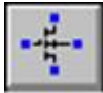

Figure 3: How to Define the HP4145 GPIB Address

Step 4: Create the Test Setup

Test setups are created in the Setup Editor. Open the Setup Editor by selecting the SETUP EDITOR toolbar button. In this example, we will create a test setup that measures the forward current of an NP diode with respect to a forward voltage sweep.



Click the corresponding toolbar button to display the Setup Editor.

Step 4A: Specify the Test Setup Name

When creating a new test setup, a test setup name must be specified before any other selections or conditions are designated.

How to Specify the Test Setup Name

1. Click the Setup Editor NEW button. This will open the New Setup dialogue box.
2. At the prompt, specify a test setup name. For this example, type "DiodeOn".
3. Click OK. This will close the New Setup dialogue box.
4. The test setup name will appear in the Setup Editor SETUP window.

Step 4B: Select a Device Schematic Corresponding to the DUT

A device schematic is located at the center of the Setup Editor. The device schematic is designed to provide a graphic image of the test fixture socket.

A MOSFET schematic will appear at the center of the Setup Editor when the Setup Editor is first opened. In this step the MOSFET schematic will be replaced with a diode schematic. The MOSFET device is the default Setup Editor schematic. To change the default device schematic, refer to *Chapter 2: The Setup Editor* of the ICS Reference Manual.

How to Select a Device Schematic:

1. Click the Setup Editor DEVICE button. This will open the Device dialogue box.
2. The Device Type window will display a list of available device schematics. Select DIODE. Notice the selected schematic is previewed in the small window to the right of the Device Type window.
3. Some device schematics will display a set of polarity switches when selected. Select the "NP" designation for this example.
4. Click OK. This will close the Device dialogue box and display the diode schematic at the center of the Setup Editor.

Step 4C: Designate the Source/DUT Connections

The source/DUT connections are designated in the Setup Editor. The Setup Editor display is provided as a tool to document the hardware connections required for the corresponding device measurement. The source/DUT connections designated in the Setup Editor are a graphic representation of the physical connections between the instrument and the test fixture. The connections designated in the Setup Editor must correspond to the reality of your hardware arrangement.

The Setup Editor displays a device schematic representing the DUT. Connections are designated by first clicking one of the available source units listed in the Source Units dialogue box. After the source unit is selected, click the blue pad next to one of the device schematic pins. Select the blue pad corresponding to the DUT pin that the source unit will be physically connected to. An instrument icon, along with the name of the connected source unit, will appear above the device schematic pin as a means of indicating the connection. This example will connect an HP4145 SMU to each end of an NP diode.

How to Designate the Source/DUT Connections:

1. Select the Setup Editor SOURCES button. This will open the Source Units dialogue box.
2. The Source Units dialogue box will display a list of available sources. The Source Units dialogue box will display four stimulus/measurement units, two voltage source units, and two voltage monitor units.
3. Click on the desired source. For this example, click on the "HP4145.SMU1" designation.
4. Designate the source/DUT connection by clicking on the blue pad corresponding to the appropriate device schematic location. For this example, connect SMU1 to the diode anode by clicking on the corresponding blue pad.
5. Repeat this process for each source connected to the DUT. For this example, select the "HP4145.SMU2" designation and connect it to the cathode.
6. After all of the source/DUT connections are designated, close the Source Units dialogue box by double-clicking the "-" in the upper left-hand corner of the dialogue box.
7. If an incorrect source/DUT connection is mistakenly designated, undesignate the connection as described in *Chapter 2, Removing Instrument/DUT Connections*.

Step 4D: Specify the Source/Measure Configuration of Each Source

Every available source has its own Source Unit Setup dialogue box used to specify the source/measure configuration of the respective SMU, Vs, or Vm. Once a source/DUT connection is designated, the corresponding Source Unit Setup dialogue box is opened by clicking on the instrument icon displayed above the respective device schematic location.

In this example, SMU1 (connected to the anode) will source a linear voltage sweep. The sweep will start at 0.0V and stop at 1.0V and consist of 51 data points. SMU1 will measure voltage (V) and current (I). SMU2 (connected to the cathode) will source a constant voltage of 0.0V and will not measure anything.

How to Specify the Source/Measure Configuration of Each Source:

1. Click once on one of the displayed instrument icons to open the Source Unit Setup dialogue box corresponding to the connected SMU.
2. Configure the SMU1 controls as shown in Figure 4. Configure the SMU2 controls as shown in Figure 5. Use the mouse or TAB key to move between the different switches and fields in each Source Unit Setup dialogue box.
3. Click OK to close a Source Unit Setup dialogue box. Only one Source Unit Setup dialogue box can be opened at a time.

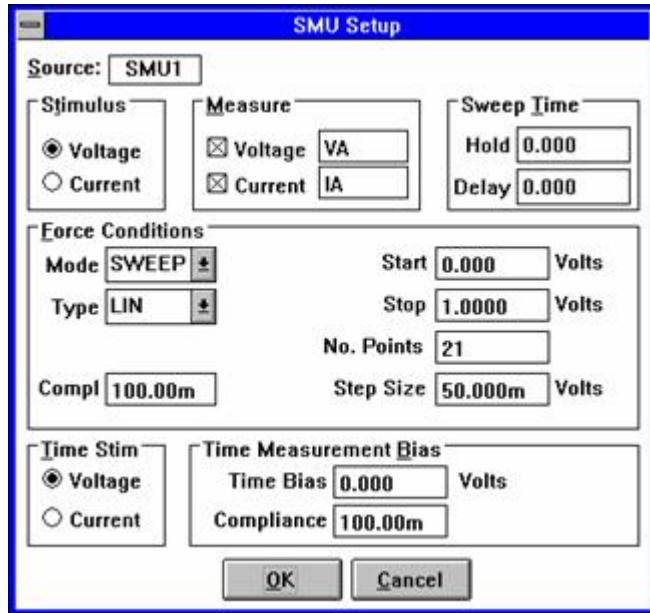

Figure 4: SMU1 Source/Measure Configuration for the DiodeOn Test Setup

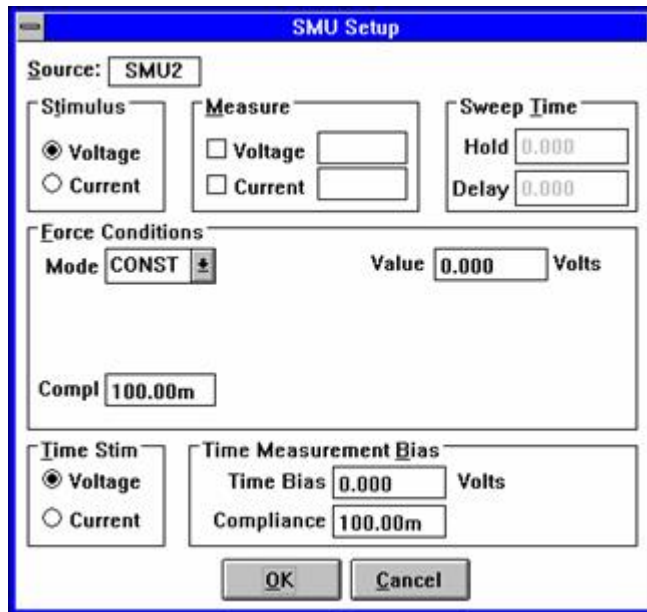

Figure 5: SMU2 Source/Measure Configuration for the DiodeOn Test Setup

Step 5: Insert the DUT Into the Test Fixture

Insert the DUT into the test fixture personality board according to the source/DUT connections designated in the Setup Editor.

Step 6: Execute the Measurement

Execute the DiodeOn test setup by clicking the toolbar MEASURE button. Shortly after the measurement is in process, a message will appear on your screen telling you that the test setup is being executed.

After a few moments another message will be displayed telling you that SMU1 reached compliance. Click IGNORE to complete the measurement.

Step 7: View the Results

Data is automatically generated in the corresponding data window spreadsheet each time the measurement is executed. To display the numerical data, double-click on the white spreadsheet icon labeled "DiodeOn" at the bottom of the ICS desktop. The spreadsheet existed before you executed the measurement, but it contained no data.

Data window spreadsheets are dynamically linked to the test setup. Each time the corresponding test setup is executed, the spreadsheet data is replaced with the most recently measured data. For this reason the data window spreadsheet is automatically named the same as the test setup.

Step 8: Create a Plot of the Results

A plot window is dynamically linked to a corresponding data window spreadsheet. This means that the plot is regenerated any time there is a change to the corresponding spreadsheet data. If the test setup is executed more than once, the plot window is regenerated after each measurement. If the data window spreadsheet is edited, the plot window is updated by clicking the REDRAW button at the top of the spreadsheet. Up to ten plots can be created from a single data window spreadsheet, and each plot can be independently formatted.

The steps below will show you how to create a plot of diode current with respect to the forward voltage sweep. This plot will correspond to the DiodeOn data.

How to Create a Plot

1. If there is more than one defined test setup, designate the active test setup in one of two ways:
 - a. Click once on the appropriate data window spreadsheet icon (the data window can be either displayed or minimized).
 - b. Click the toolbar setup window arrow and select the desired setup from the displayed drop-down list.
2. Click the NEW PLOT toolbar button. This will open an empty plot window and the Plot Data dialogue box.
3. Designate the independent variable of the plot by double-clicking on the appropriate data vector listed in the Data window. Only two quantities were measured in the DiodeOn test setup, voltage and current. There should be two data vectors in the dialogue box Data window: "V" and "I". This example will create a plot of current with respect to voltage. Since voltage will be the independent variable, double-click on "V". Notice that the X-button is now labeled with a "V".
4. Designate the first dependent variable of the plot (in our case the only dependent variable) by double-clicking the appropriate data vector in the dialogue box Data window. For this example, double-click on the "I". Notice that the Y1-button is now labeled with an "I".
5. You could plot up to nine more data vectors with respect to the independent variable if more data vectors were measured. You can measure more than ten data vectors, but only ten data vectors can be plotted in a single plot window.

6. Click the dialogue box APPLY button. This will create the plot but will not close the Plot Data dialogue box. You should notice that at about 0.6V the diode turned on.
7. Click the CLOSE button to close the Plot Data dialogue box.

Step 9: Save the Results into a Project File

A project file includes all of the information necessary to execute a test setup or group of test setups. A single project file includes: 1) the instrument driver selection, 2) any defined test setup(s), and 3) all of the data and plot windows associated with the test setup(s). For more information about project files, refer to *Chapter 1: How ICS Stores Information*.

How to Save Your Work as a Project File

1. Click the SAVE AS toolbar button or select FILE/SAVE AS... from the menu bar. This will open the Save As Dialogue.
2. Enter a filename and select the directory to save the file.

Source Unit Availability

The HP4145 is comprised of eight channels. Channels #1 through #4 are Stimulus/Masurement Units (SMUs), Channels #5 and #6 are Voltage Source Units (VSs), and Channels #7 and #8 are Voltage Monitor Units (VMs). In ICS, each HP4145 channel is referred to as a "source unit" (even though the VMs don't source an output). Each of the eight source units are listed in the Source Units dialogue box opened by clicking the SOURCES button in the Setup Editor. All eight source units are identified by an instrument prefix followed by a functional designation and a sequence number. For example, ICS identifies Channel #3 as "HP4145.SMU3", and Channel #7 as "HP4145.VM1".

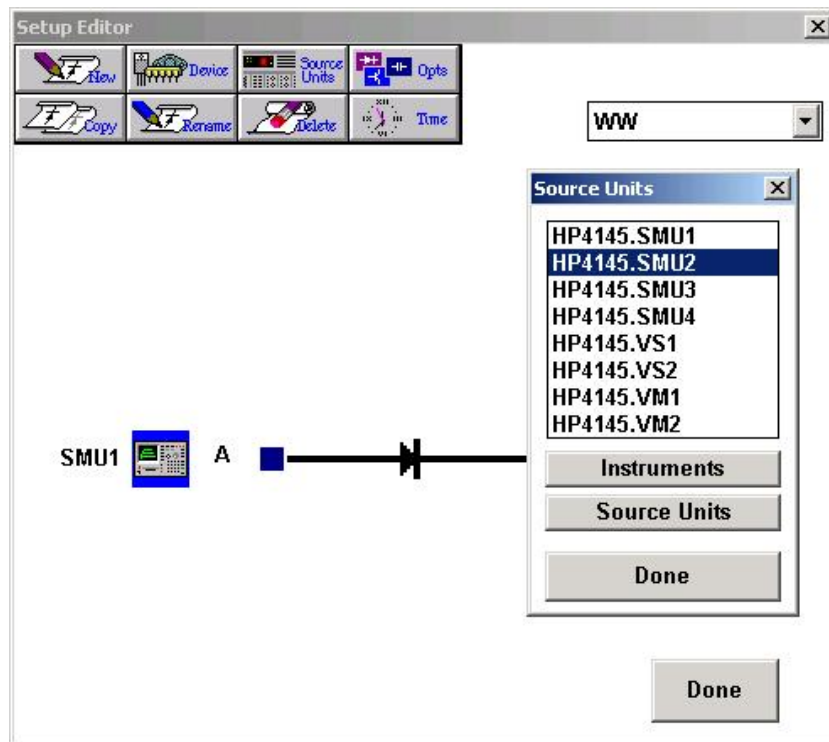

Figure 6: Each HP4145 Channel is Identified as a "Source Unit". All Eight Source Units are Identified by an Instrument Prefix Followed by a Functional Designation and a Sequence Number.

The Source Unit Setup Dialogue Box

The setup conditions of each instrument source unit are independently controlled from a Source Unit Setup dialogue box. There is a Source Unit Setup dialogue box that corresponds to each HP4145 source unit. Each Source Unit Setup dialogue box is accessed from the Setup Editor. An example of a Source Unit Setup dialogue box is shown in Figure 7.

How to Display a Source Unit Setup Dialogue Box:

In order to display a Source Unit Setup dialogue box, the corresponding source must be attached to the device schematic in the Setup Editor.

1. If only one source unit connection is designated at the same schematic pin, click once on the instrument icon to open the corresponding Source Unit Setup dialogue box.
2. If more than one source unit connection is designated at the same schematic pin, click once on the instrument icon to display a list of designated source unit connections.
3. Click once on the desired source unit designation to select the source unit; double-click on the source unit designation to open the corresponding Source Unit Setup dialogue box.

The layout of a Source Unit Setup dialogue box is similar to the example pictured below.

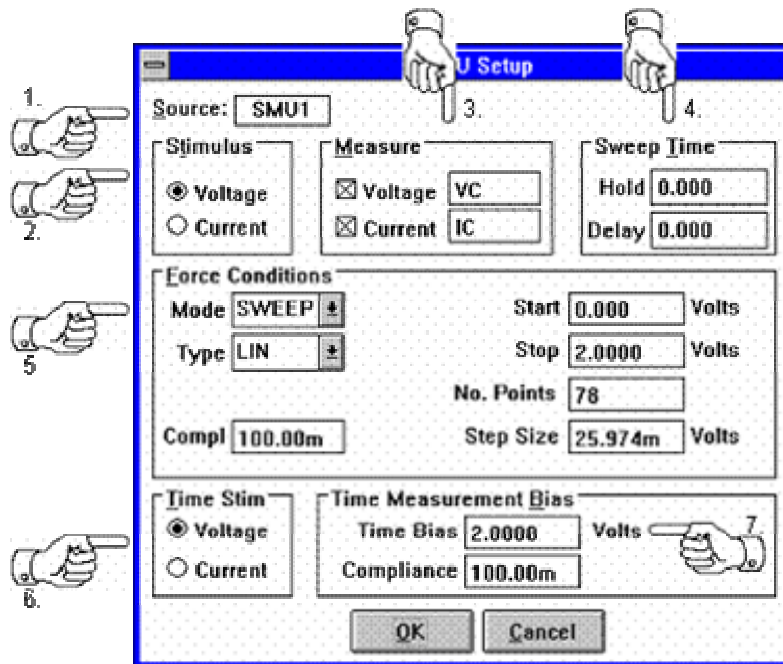

Figure 7: The Source Unit Setup Dialogue Box Corresponding to "SMU1" (Channel #1).

1. **Source Unit Identity Field:** This field is a static display identifying the suffix of the source unit label as designated in the Source Units dialog box.
2. **Stimulus Controls:** This group consists of a pair of switches used to identify whether the forcing signal is a voltage or a current.
3. **Measure Controls:** This group includes the switches necessary to specify the type of signal the source unit will return as a measurement. This group also includes the necessary fields to label the returned measurements.
4. **Sweep Timing Controls:** This group includes the fields necessary to specify the Hold Time and Delay Time parameters.
5. **Force Conditions Controls:** The fields included within this group are used to define the shape of the forcing signal as well as the forcing signal's start and stop values. The compliance field is also included within this group.
6. **Time Stimulus Switch:** The Time Stimulus Switch allows the user to select the type of stimulus to use during ICS Time measurements.
7. **Time Measurement Bias:** The Time Measurement Bias value indicates the source value to be used during ICS Time measurements.



Force Conditions Controls

The Force Condition controls are used to specify the shape and boundaries of the forcing signal, as well as the forcing signal's compliance limit. Integration controls are configured from the HP4145 Mainframe Setup dialogue box.

Mode

The shape of the forcing signal is selected from a list of available signal outputs in the MODE field. The forcing signal may be characterized as a SWEEP, SYNCHRONIZED SWEEP, STEP, or CONSTANT supply. (These designations are the ICS equivalent of the VAR1, VAR1', VAR2, and CONST front panel source functions.) To select the desired sweep mode, click the MODE field scroll arrow. Clicking on the scroll arrow will display a list of available sweep modes. Click on the desired selection.

Sweep Mode

Force Conditions				
Mode	SWEEP 	Start	0.000	Volts
Type	LIN 	Stop	2.000	Volts
Compl	100.0m	No. Points	201	
		Step Size	10.00m	Volts



The sweep mode generates either a linear or logarithmic staircase sweep signal between two specified boundary values.

When creating a test setup that includes a second, synchronized sweep signal, the sweep application described in this section is the primary sweep signal.

How to Source a Sweep Signal:

1. Select the "SWEEP" designation from the available options listed in the MODE field.
2. The data point distribution of the sweep signal can be either linearly or logarithmically distributed between the START and STOP values specified in Step #3. Select between a linear or logarithmic distribution by selecting the appropriate designation in the TYPE field.
3. Specify the range of the sweep signal in the START and STOP fields.
4. Hitting the tab key from the STOP field will move the cursor to the NO. POINTS field. Enter the number of data points that will comprise the sweep signal.
5. If a linear sweep type is selected in Step #2, the Sweep controls will include a STEP SIZE field. The STEP SIZE field will be calculated automatically after a value is entered in the NO. POINTS field and the cursor is moved to another location (or OK is selected). If desired, the calculated STEP SIZE can be updated by the user. If a new value is entered in the STEP SIZE field, the STOP field will be updated to accommodate the new STEP SIZE value. If any of the other fields are edited, the STEP SIZE field will be automatically updated to accommodate the change.

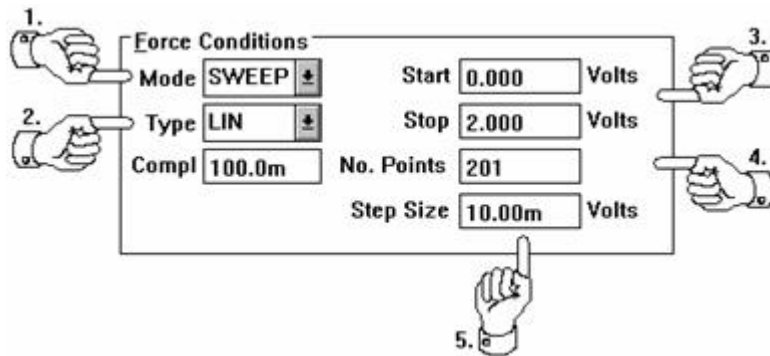

Figure 8: How to Source a Sweep Signal

Synchronized Sweep Mode

Force Conditions			
Mode	SYNC	Ratio	1.200
Type	LIN	Offset	250.0m Volts



A synchronized sweep is a linear sweep signal that is synchronized in time with a primary sweep signal applied by another source unit.

A source unit can force a synchronized output only when a primary sweep signal is forced by another source unit in the test setup. If a synchronized sweep mode is designated in a test setup that does not include a primary sweep signal, ICS will display an error message when the user attempts to execute the test setup.

The data point distribution of both the primary sweep signal and the synchronized sweep signal must be linearly calculated. ICS will generate an error message if the user attempts to configure a synchronized sweep output in a test setup that includes a *logarithmic* primary sweep source. The data point distribution of the synchronized sweep signal is automatically designated as LINEAR. When a SYNC output is selected in the Force Conditions MODE field, the TYPE field is locked in the LINEAR configuration.

The stimulus of the synchronized sweep signal must match the stimulus of the primary sweep. In other words, if the primary sweep signal forces a voltage, the synchronized sweep signal must also force a voltage. If the synchronous signal is configured after the primary signal, the corresponding Stimulus switch will be selected automatically in the SYNC source. The alternative Stimulus switch will be unavailable to the user as indicated by the gray color of the switch.

While the *timing* of the primary and secondary sweep signals are synchronized, the magnitudes can differ. The magnitude of the synchronous signal is specified relative to the primary sweep by designating a constant ratio and/or a constant offset. The meaning of "ratio" and "offset" is explained in Figure 9.

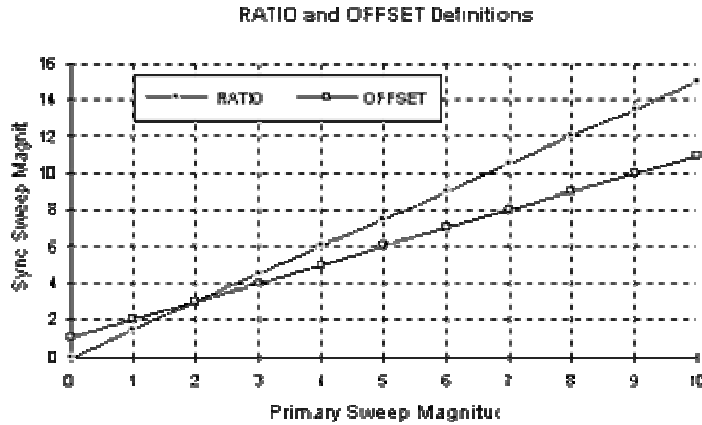

Figure 9: Synchronous Sweep "Ratio" and "Offset" Definitions.

When a RATIO is specified:

$$\text{Sync Sweep Mag} = \text{Primary Mag} * (\text{Ratio})$$

When an OFFSET is specified:

$$\text{Sync Sweep Mag} = \text{Primary Mag} + (\text{Offset}).$$

How to Source a Synchronized Sweep Signal:

A synchronized sweep signal is functional only when a linear sweep signal is forced by another source unit.

1. Select the "SYNC" designation from the available options listed in the MODE field.
2. The data point distribution of both the primary and synchronous sweep signals must be linearly calculated. For this reason, the TYPE field will be locked in the LINEAR configuration.
3. The output stimulus of the synchronous sweep must match the output stimulus of the primary sweep. If the synchronous sweep is configured after the primary sweep is defined, the corresponding

- Stimulus switch (VOLTAGE or CURRENT) will be selected automatically. The alternative switch will be unavailable.
- If desired, specify a value in the OFFSET field. When an offset value is specified, the offset component of the synchronized sweep magnitude is the sum of the primary sweep magnitude and the OFFSET value.
 - If desired, specify a value in the RATIO field. When a ratio value is specified, the ratio component of the synchronized sweep magnitude is the product of the primary sweep magnitude and the RATIO value. A synchronized ratio **CANNOT** be specified in combination with a synchronized offset.



A synchronized ratio **CANNOT** be specified in combination with a synchronized offset.

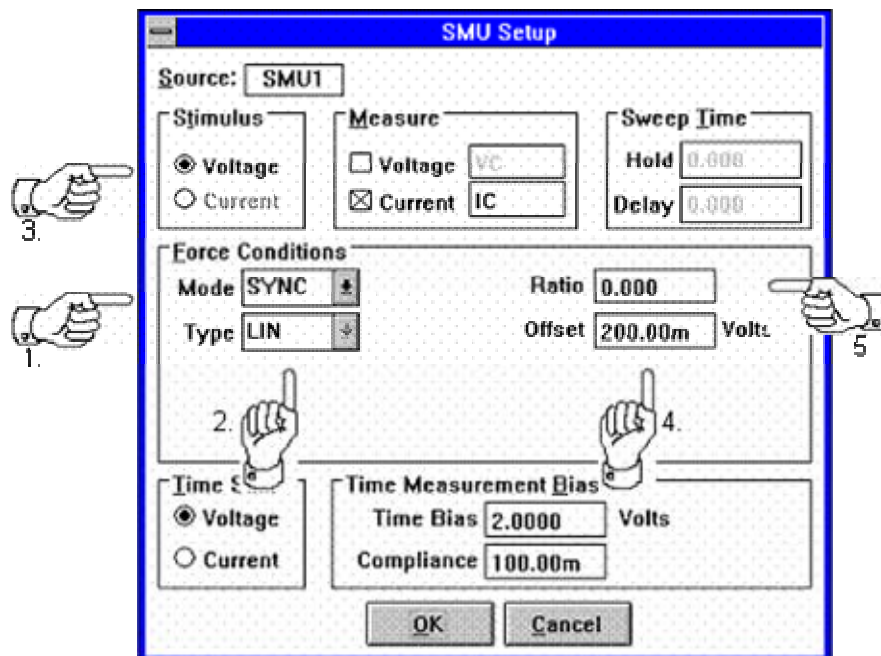

Figure 10: How to Source a Synchronized Sweep Signal

Step Mode

Force Conditions			
Mode	STEP	Start	10.00u Amps
Type	LIN	Stop	60.00u Amps
Compl	1.000	No. Steps	6
		Step Size	10.00u Amps



The step mode forces a constant output while another source unit in the test setup forces a sweep signal. The step mode is functional only in test setups that include a second source unit configured in sweep mode.

The step mode generates a constant output signal while a second source unit generates a sweep signal. After the sweep signal reaches the specified STOP value, the magnitude of the step output is incremented by the STEP value and the sweep output is triggered again. This process continues until the STOP value of the step signal is reached.

A STEP mode output signal can only be incremented by a constant value. When "STEP" is designated in the Force Conditions MODE field, the TYPE field will be locked automatically in the LINEAR configuration.

How to Source a Step Signal:

1. Select the "STEP" designation from the available options listed in the MODE field.
2. The STEP mode output signal can only be incremented by a constant value. For this reason, the TYPE field is locked in the LINEAR configuration.
3. Specify the range of the step signal in the START and STOP fields.
4. Specify the increment quantity in the NO. STEPS field.
5. The increment size will be displayed in the STEP SIZE field. After a value is entered in the NO. STEPS field and the cursor is moved to another location (or OK is selected), the STEP SIZE field will be calculated automatically. If desired, the calculated STEP SIZE can

be updated by the user. If a new value is entered in the STEP SIZE field, the STOP field will be updated to accommodate the new STEP SIZE value. If any of the other fields are edited, the STEP SIZE field will be updated automatically to accommodate the change. The step mode can only be used in test setups that also include the specification of a sweep signal. A source unit configured in a step mode will force a constant value signal while a second source unit generates a sweep signal. After the sweep signal has been applied, the step value will be incremented in preparation for another sweep application. This process continues until the stop value of the step signal is reached.

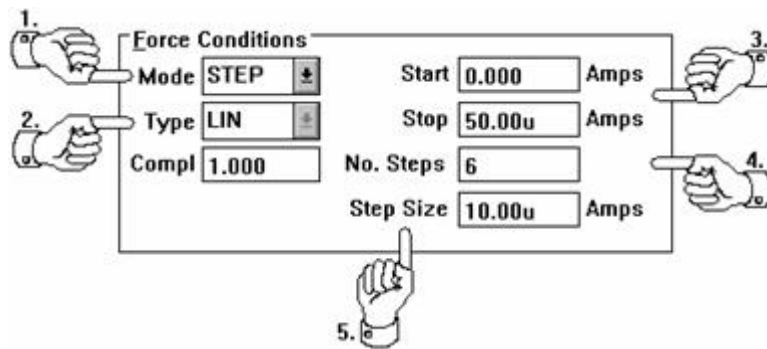

Figure 11: How to Source a Step Signal

Constant Mode

Force Conditions	
Mode	CONST <input type="button" value="±"/>
Value	250.0m Volts
Compl	100.0m



The constant mode generates a signal that remains at a constant magnitude throughout the duration of the test setup.

How to Source a Constant Signal:

1. Select the "CONST" designation from the available options listed in the MODE field.
2. Specify the signal magnitude in the VALUE field.

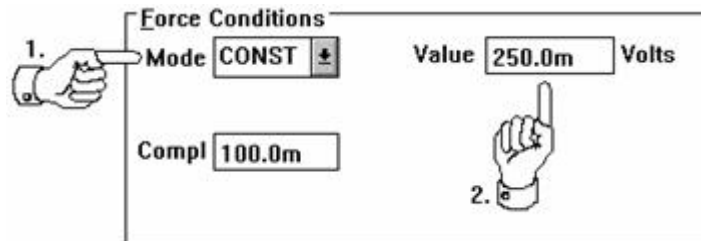

Figure 12: How to Force a Constant Signal

Type

The TYPE field is used to designate whether the data point distribution of a sweep output is linearly or logarithmically calculated. This field is displayed when the SWEEP designation is selected in the MODE field. If the STEP or SYNC mode is active, the TYPE field is locked in the LINEAR configuration.

Start

The START field is used to specify the starting value of the sourcing signal. This field is displayed when the SWEEP or STEP designation is selected in the MODE field.

Stop

The STOP field is used to specify the stopping value of the sourcing signal. This field is displayed when the SWEEP or STEP designation is selected in the MODE field.

No. Points

The NO. POINTS field is used to specify the data point quantity in a linear sweep signal. This field is displayed when the SWEEP designation is selected in the MODE field and the LINEAR designation is selected in the TYPE field.

Pts/Dec

The PTS/DEC field reports the number of data points that will be measured per sweep decade. The PTS/DEC field can not be edited by the user. The number reported in this field is determined by the logarithmic selection configured in the TYPE field.

No. Steps

The NO. STEPS field is used to specify the increment quantity of a step signal. This field is displayed when the STEP designation is selected in the MODE field.

Step Size

The STEP SIZE field designates the linear increment of a sweep or step signal. The value of this field is automatically calculated after the user specifies either the NO. POINTS in a linear sweep or the NO. STEPS in a step output. If the value of this field is changed by the user, the value of the STOP field will be updated to accommodate the change. This field is displayed when the STEP designation is selected in the MODE field. The STEP SIZE field is also displayed when the SWEEP designation is selected in the MODE field, and the LINEAR characteristic is selected in the TYPE field.

Value

The VALUE field is used to specify the magnitude of a constant signal. This field is displayed when the CONSTANT designation is selected in the MODE field.

Offset and Ratio

These fields are used to configure the output a synchronous output. These fields are displayed when the SYNC designation is selected in the MODE field.

Compliance

The COMPLIANCE field is used to specify the limiting magnitude of a measured signal. When a source unit is forcing voltage and measuring current, a current compliance must be specified. Similarly, if a source unit is sourcing current and measuring voltage, a voltage compliance must be specified. Depending upon the source units being used, the compliance limit may be locked at a particular value.

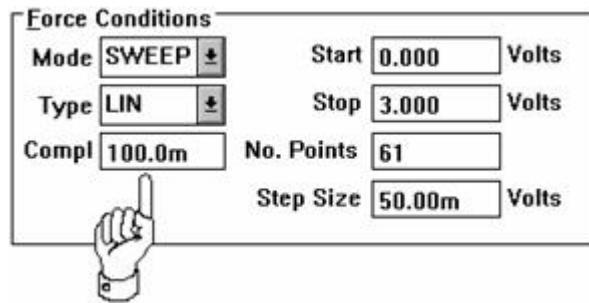

Figure 13: Designating a Measurement Compliance

The compliance limit allows the user to execute a test setup that is within an acceptable power range of the device by limiting the operating range of the source unit. For example, if a 100mA compliance limit is specified for a source unit that is sourcing a sweep voltage and returning a current, the source unit will supply an increasing voltage signal until a 100mA current is returned.

The maximum compliance limit that ICS will allow is determined by the operating boundaries of the instrument. Please refer to Chapter 3 of the HP4145A/B Operations Manual for an overview of the HP4145 compliance configurations and power limitations.

Detecting Compliance Events

If the Report Compliance switch is selected in the Mainframe Setup dialogue box, ICS will halt the active measurement and display a message if a compliance limit is detected. (The Mainframe Setup dialogue box is opened by clicking the Setup Editor OPTIONS button.) The message box will identify the source unit in compliance and present the user with the options of retrying the test setup, aborting the test setup, or ignoring the message. After selecting an option, ICS will close the message box and proceed as instructed.

As a default, the Report Compliance switch is OFF. If you want ICS to identify compliance events, make certain that the Report Compliance switch is selected in the Mainframe Setup dialogue box.

Stimulus Controls

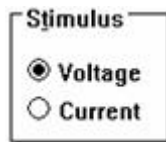

The Stimulus controls consist of two switches: VOLTAGE and CURRENT. These switches are used to specify the electrical characteristic of the forcing signal.

Depending upon the source, one of the two switches may be unavailable. For example, the HP4145 Voltage Monitor Units (VMs) are designed for high resolution voltage measurements. VMs can NOT be configured to force a voltage.

Measure Controls

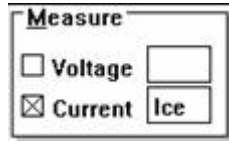

The Measure controls consist of two switches: VOLTAGE and CURRENT. In addition to the two measure switches, a text field is located to the right of each switch. These switches and text fields are used to specify and label the data that will be returned when the test setup is executed.

Specifying Returned Data

Depending upon the particular HP4145 source, ICS may be configured to return the forcing signal, the forcing signal complement, both, or none. For an overview of each source's capability, please refer to Chapter 3 of the HP4145A/B Operations Manual.

A source's measurement configuration is specified by turning on or off the VOLTAGE and CURRENT switches. Depending upon the particular source, one of the two switches may be unavailable.

How to Specify Returned Data:

1. Open the Source Unit Setup dialogue box corresponding to the source that will return data.
2. Click on one or both of the measure switches.
3. After you select either of the measure switches, a default text label will appear in the field next to the corresponding switch. If the default label is unacceptable, specify an alternative name for the measured characteristic.

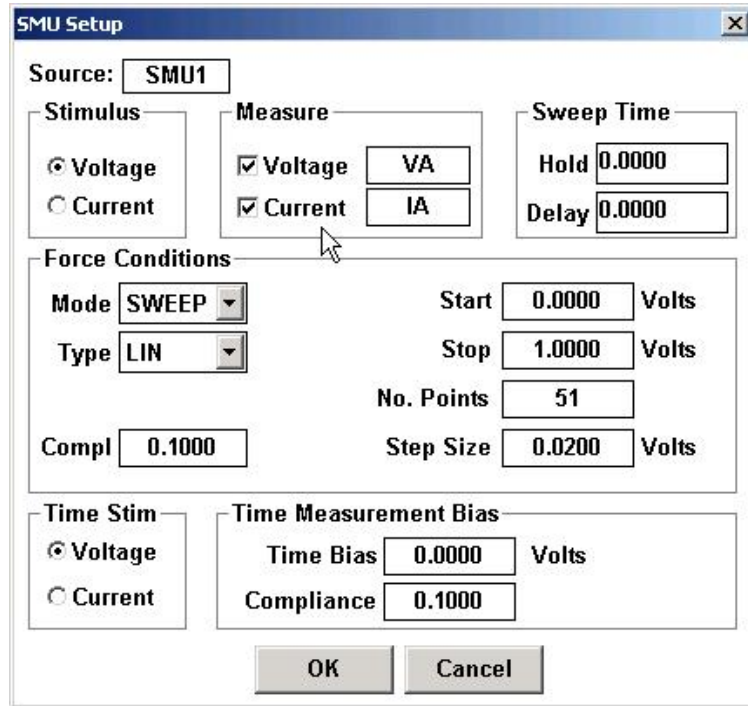

Figure 14: How to Specify Returned Data

Labeling Measured Data

All of the data that corresponds to a single curve is collectively referred to as a "data vector". Each data vector is identified by a "data vector label" that must be defined in the text field to the right of the VOLTAGE or CURRENT switch. A data vector label can be any alphanumeric string up to three characters in length.

The presence of only two data vector fields does not mean that only two data vectors can be specified in a test setup. In fact, by using a combination of step and sweep sources, up to 42 data vectors per test setup can be measured.

Test setups that use a combination of step sources and sweep sources can return sequential and non-sequential data vectors. Test setups that use a combination of constant sources and sweep sources can only return non-sequential data vectors.

Sequential Data Vectors

A sequential data vector is a device characteristic that is described by a family of unique curves. Each curve is measured in response to a stepped bias condition. Sequential data vectors are the result of test setups that include stepped sources and repeated sweeps.

For example, consider the DC collector characteristics of a bipolar transistor. The DC collector characteristics were obtained by generating a family of I_{CE} vs. V_{CE} curves. This setup was created by applying a stepped current supply to the base and a swept voltage supply to the collector. The source unit connected to the collector returned both collector voltage (V_{CE}) and collector current (I_{CE}). Each time the base current was stepped to a new value, a unique I_{CE} curve was obtained in response to the collector voltage sweep. The result of this test setup was a family of unique I_{CE} curves. I_{CE} is a sequential data vector because collector current is described by a family of unique curves measured in response to stepped base current.

Non-Sequential Data Vectors

A non-sequential data vector is a device characteristic that is described by a single curve.

For example, consider the example presented in the previous section, *Sequential Data Vectors*. The DC collector characteristics of a bipolar transistor were obtained by generating a family of I_{CE} vs. V_{CE} curves. This setup was created by applying a stepped current supply to the base and a swept voltage supply to the collector. The source unit connected to the collector returned both collector voltage (V_{CE}) and collector current (I_{CE}). Because the base current was stepped, the test setup returned a family of I_{CE} curves, but the voltage sweep applied to the collector during each base current step was the same. Therefore, V_{CE} is a non-sequential data vector because V_{CE} can be described by a single curve.

Sweep Timing Controls

Sweep Time	
Hold	5.000m
Delay	5.000u



A hold time and delay time may be specified when forcing a sweep signal. Hold time is the amount of time the instrument will wait before applying the sweep output. Delay time is the time the instrument will wait between consecutively forced sweep points.

Mainframe Options

The Mainframe Setup dialogue box provides access to the HP4145 Integration and Time Domain controls. The Mainframe Setup dialogue box also includes the Single/Repeat Measure option along with the Report Compliance status switch. The latter features are unique to ICS. The Single/Repeat Measure option and the Report Compliance status switch do not correspond to any of the front-panel instrument controls.

The configuration of the Mainframe Setup dialogue box can be uniquely specified for each test setup. Mainframe setup options are not specific to a single source unit; instead, mainframe setup options are applicable to every source unit in the test setup. In general, the default specifications in this dialogue box will be sufficient for most measurement applications. It will probably not be necessary for the user to configure the Mainframe Setup dialogue box each time a new test setup is created.

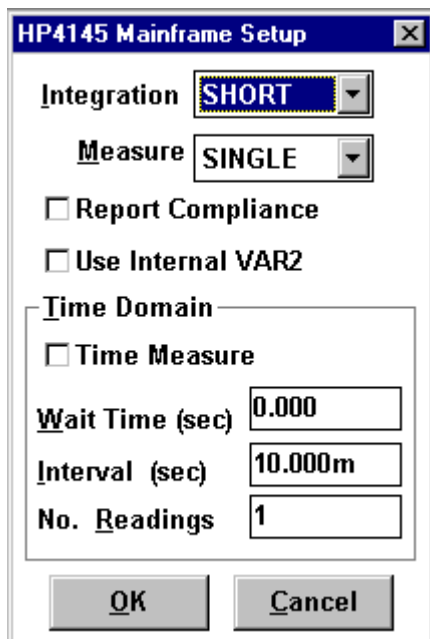

The Mainframe Setup dialogue box is opened by clicking the Setup Editor OPTIONS button after designating at least one Source Unit/DUT connection. The HP4145 Mainframe specifications are applicable to every source unit in the test setup. When a new test setup is created, the Mainframe Setup dialogue box can be designated without affecting the mainframe setup configuration in the original test setup(s).



The HP4145 Mainframe Setup dialogue box is opened by clicking the Setup Editor OPTIONS button after designating at least one Source Unit/DUT connection.

Integration Time

In order to minimize the effects of line frequency interference and other noise sources, the HP4145 is equipped with three digital integration modes:

1. **Short:** Digital integration is not performed.
2. **Medium:** The measurement result is the average of 16 samples taken during one line frequency period.
3. **Long:** The measurement result is the average of 256 samples taken during sixteen line frequency periods.

If your measurement data includes random variations in magnitude, consider selecting a longer integration time. To select a new integration time, click the scroll arrow at the right of the Integration field to display a list of available designations. Click on the desired option.

NOTE: As a default, the Integration field will be configured in SHORT mode. Selecting a longer integration time will increase the time required to complete the measurement.

Single/Repeat Measure Mode

Single Measure

When ICS is configured in Single Measure mode, ICS will always configure the HP4145 Channel Definition Page and Source Unit Setup Page prior to initiating the test setup measurement. ICS will not pay attention to whether the instrument setup information is already loaded in instrument memory. As a default, ICS will operate in Single Measure Mode.

Repeat Measure

The functionality of the Repeat Measure option is not equivalent to the functionality of the HP4145 front-panel Repeat Measurement key. The Repeat Measure option is exclusive to the ICS HP4145 Instrument Driver. This instrument enhancement is designed to improve measurement speed during the consecutively repeated execution of a single test setup.

Repeat mode eliminates the time spent redundantly configuring the instrument when the same test setup is repeatedly executed. When a test setup is executed in Repeat mode, ICS will determine if the present test setup information is already configured in instrument memory. This is determined by identifying whether the presently executed test setup is identical to the previously executed test setup. ICS determines if this is the case by tracking whether the user 1) changed focus to a different test setup, or 2) edited the test setup definition. If neither of these situations occurred, ICS will discern that the present test setup execution is a repetition of the previously executed test setup.

When ICS detects the repeated execution of a test setup, ICS will skip the instrument setup steps and immediately trigger the instrument to initiate the measurement. (An exception occurs during test setups that include a source unit configured in STEP mode. In terms of the HP4145, source units configured in STEP mode are applied to the DUT by repeated applications of a single stepped VAR2 source. When a test setup of this type is executed in Repeat mode, the Source Setup Page will be displayed momentarily while ICS updates the Start and Step value for the VAR2 source channel. The time required to update the Source Unit Setup page is minimal since only two fields require revision.) This will be apparent by the appearance of the List Display Page on the instrument's front panel almost immediately after the toolbar MEASURE button is selected. ICS will not spend time configuring the HP4145 Channel Definition Page and Source Setup Page.

Configuring these HP4145 screens during a repeated measurement is redundant because this information is still in instrument memory as a result of the last test setup execution.

The first time a test setup is executed in Repeat mode, ICS must send the test setup information to the instrument just as ICS does in Single mode. As long as the user repeatedly executes the same test setup, ICS will skip the instrument setup steps and immediately trigger the instrument to initiate the measurement each time the toolbar MEASURE button is selected. If the cycle is interrupted by executing a different test setup or editing the present test setup, the instrument configuration stored in instrument memory will no longer correspond to the active test setup. If the user initiates a new cycle of repeated measurements using the Repeat mode test setup, ICS will configure the instrument prior to the first measurement but eliminate the setup steps for each consecutively repeated execution of the test setup.

Report Compliance

Selecting the Report Compliance switch will configure ICS to report compliance events. If the Report Compliance switch is selected, ICS will halt the active measurement and display a message box when a compliance event is detected. The message box will identify the source unit in compliance and present the user with the options of retrying the test setup, aborting the test setup, or ignoring the message. After selecting an option, ICS will close the message box and proceed as instructed.

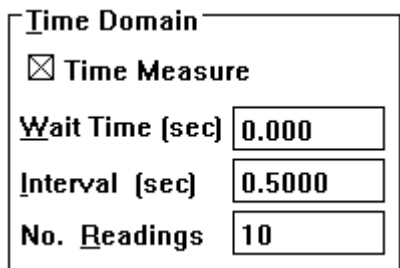

Figure 15: ICS Reports Compliance Events if the Report Compliance Switch is Selected in the Mainframe Setup Dialogue Box.

As a default, the Report Compliance switch is OFF. If you wish ICS to identify compliance events, make certain that the Report Compliance switch is selected in the Mainframe Setup dialogue box.

Time Domain

The HP4145 firmware includes a time domain utility that will return measured device parameters as a function of time. The HP4145 Time Domain utility is internal to the instrument and is distinct from the time domain utility provided in the ICS Setup Editor. The HP4145 Time Domain mode is configured with the Time Domain controls located in the HP4145 Mainframe Setup dialogue box. The ICS Time Domain utility is configured with the controls located in the Setup Time dialogue box opened by selecting the Setup Editor TIME button. For more information about configuring an HP4145 test setup using the ICS Time Domain utility, refer to *Chapter 2: The Setup Editor, Creating a Time Domain Test Setup*.



The screenshot shows a dialog box titled "Time Domain". It contains a checked checkbox labeled "Time Measure". Below this are three input fields: "Wait Time (sec)" with the value "0.000", "Interval (sec)" with the value "0.5000", and "No. Readings" with the value "10".

Time Domain	
<input checked="" type="checkbox"/> Time Measure	
Wait Time (sec)	0.000
Interval (sec)	0.5000
No. Readings	10

Figure 16: The HP4145 Time Domain Utility is Internal to the Instrument and is Distinct from the ICS Time Domain Utility.

Functionality

When the HP4145 Time Domain utility is implemented in a test setup, the VAR1 signal sweep is replaced with a time sweep. A family of curves measured with respect to time can be generated by incrementing the output of one source unit while the remaining source unit(s) output a constant signal. The source unit must be incremented by configuring the source unit in STEP mode (VAR2 source). All other source units connected to the DUT must be configured in CONSTANT mode. (The STEP source is optional. The HP4145 Time Domain utility is functional when all of the source units connected to the DUT are configured in CONSTANT mode.) When the test setup is executed, TIME will be returned to the first column of the data window spreadsheet. Additional spreadsheet columns will be occupied by returned data. (The structure of the data window spreadsheet suggests that time be plotted as the independent variable, though any data vector can be designated as the independent variable from the Setup Data dialogue box.) If the user configures an HP4145 Time Domain test setup and later

configures one of the source units in either of the SWEEP modes, the time domain utility will be disabled automatically.

Time Measure

The Time Measure switch turns ON or OFF the HP4145 Time Domain utility. The HP4145 Time Domain utility supports test setups incorporating either all constant sources or constant sources with one stepped source. If one of the source units is configured in either of the SWEEP modes after the HP4145 Time Domain utility is selected, the HP4145 Time Domain utility will be disabled automatically.

Wait Time

The wait time is the amount of time the instrument will wait before initiating the source unit outputs. Wait time must be between 0 and 100 seconds.

Interval

The interval is the amount of time the instrument will wait between consecutive measurements. The interval must be between 10 milliseconds and 10 seconds.

No. Readings

The No. Readings specification defines the total number of data points comprising the time sweep. If a source unit is configured in STEP mode, the No. Readings specification is the number of measured points that will be collected at each step value. A total of 500 or 1024 data points can be specified for the HP4145A or HP4145B respectively.

Contrasting the HP4145 and ICS Time Domain Utilities

The functionality of the HP4145 Time Domain utility is similar to ICS' Time Domain Time Measure mode with some exceptions. The HP4145 Time Domain utility is limited to 500 or 1024 data points (HP4145A or HP4145B respectively) measured at a maximum interval of 10 seconds. In other words, a time sweep configured with the HP4145 Time Domain utility is limited to a maximum duration of either 1 hour and 23 minutes or 2 hours and 50 minutes depending upon the version of the HP4145. However, the Time Measure mode configured with the ICS Time Domain utility has no practical limit. The maximum time sweep duration that can be specified in the ICS Time Domain utility is on the order of 1×10^{13} hours.

The ICS Time Domain utility provides a second measurement mode: Bias Measure. In Bias Measure mode, a device can be biased at constant conditions for a designated length of time prior to the execution of the test setup. The HP4145 Time Domain utility does not provide this capability.

The HP4145 Time Domain utility allows the user to generate a family of time sweep curves by configuring one of the source units in STEP mode. The ICS Time Domain utility does not support multiple time sweeps in the same test setup.

The table below compares the capability of the HP4145 and ICS Time Domain utilities.

Capability	HP4145 Firmware	ICS
Maximum Time Sweep Duration	1 hr 23 min (4145A)	Unlimited
Supported Modes	2 hr 50 min (4145B) Time Measure	(1×10^{13} hr) Time Measure
Multiple Time Sweeps	Yes	Bias Measure No
Control Location	HP4145 Mainframe	Time Setup
	Setup Editor Options Dialogue Box	Setup Editor Time Measurement Dialogue Box

Table 1: A Comparison of the HP4145 and ICS Time Domain Utilities

Setup Example

Collector Family

This setup measured the DC collector characteristics of a 2N3700 bipolar transistor. A voltage sweep was applied to the collector for a series of stepped base currents. A family of curves was generated by measuring and plotting the collector current with respect to the collector voltage sweep for each base current step. The following source units and setup conditions were used:

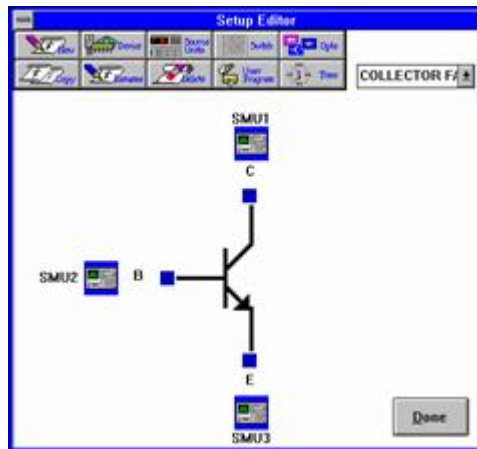

Collector Family Setup Conditions

The image shows a software dialog box titled "SMU Setup" for configuring a Source Module Unit (SMU1). The dialog is organized into several sections:

- Source:** SMU1
- Stimulus:** Radio buttons for Voltage (selected) and Current.
- Measure:** Checkboxes for Voltage (selected) and Current (selected). Voltage is set to VC and Current to IC.
- Sweep Time:** Input fields for Hold (0.000) and Delay (0.000).
- Force Conditions:**
 - Mode: SWEEP (dropdown)
 - Type: LIN (dropdown)
 - Start: 0.000 Volts
 - Stop: 2.0000 Volts
 - No. Points: 78
 - Compl: 100.00m
 - Step Size: 25.974m Volts
- Time Stim:** Radio buttons for Voltage (selected) and Current.
- Time Measurement Bias:** Input fields for Time Bias (2.0000 Volts) and Compliance (100.00m).

At the bottom of the dialog are "OK" and "Cancel" buttons.

Collector: SMU1

Mode: Voltage Sweep

Output: 0V-2V

Return: VC, IC

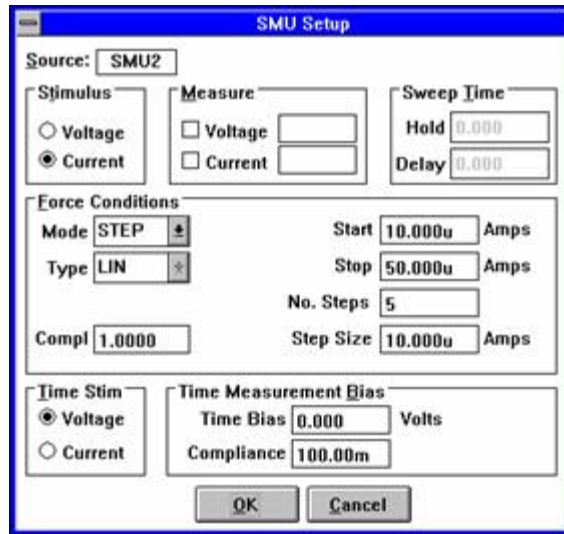

Base: SMU2

Mode: Current Step

Start: 10u

Step Size: 50u

Step Qty: 5

Return: None

Emitter: SMU3

Mode: Ground

Output: 0V

Return: None

Results

