

INSTRUCTION MANUAL

BK PRECISION®

**Models 9120A, 9121A,
9122A, 9123A & 9124**

SINGLE OUTPUT PROGRAMMABLE DC POWER SUPPLY SERIES



Safety information

Please review the following safety precautions before operating our equipment.

General information

The following safety precautions should be observed before using this product and any associated instrumentations.

This product is intended for use by qualified personnel who recognize shock hazards and are familiar with the safety precautions required to avoid possible injury. Read and follow all installation, operation, and maintenance information carefully before using the product. Refer to this manual for complete product specifications. If the product is used in a manner not specified, the protection provided by the product may be impaired.

Before performing any maintenance, disconnect the line cord and all test cables.

Protection from electric shock

Operators of this instrument must be protected from electric shock at all times. The responsible body must ensure that operators are prevented access and/or insulated from every connection point. In some cases, connections must be exposed to potential human contact.

Under these circumstances personnel must be trained to protect themselves from the risk of electric shock. If the circuit is capable of operating at or above 1000 volts, no conductive part of the circuit may be exposed.

Definition of users

Responsible body is the individual or group responsible for the use and maintenance of equipment is operated within its specifications and operating limits, and for ensuring that operators are adequately trained.

This product should only be used as intended. Users must be trained in electrical safety procedures and proper use of the instrument. Users must be protected from electric shock and contact with hazardous live circuits. Service is only to be performed by qualified service personnel.

Safety symbols and terms



Connect to safety earth ground using the wire recommended in the user manual.



This symbol on an instrument indicates that the user should refer to the operating instructions located in the manual.

Certification

We certify that this product met its published specifications at time of shipment from the factory.

TABLE OF CONTENTS

1. Introduction.....	4
Description	4
Features	4
2. Quick Reference	5
2.1 The Front Panel	5
2.2 The Rear Panel	6
2.3 Preliminary Checkout.....	6
1. Check the list of supplied items.....	6
2. Connect the power cord and turn on the power supply	7
3. Checkout Procedure	7
1.4 Output Verification	8
Current Output Check	8
1.5 If the power supply does not turn On	8
1.6 To Adjust the Carrying Handle.....	9
1.7 To Rack Mount the Instrument.....	10
3. Front-panel Operation.....	11
3.1 Front Panel Keys	11
Numerical Keys/Secondary Shift Functions.....	11
Shift Functions	11
Primary Function Keys.....	12
Up/Down and Entry key.....	12
3.2 Front-panel Operation Overview.....	12
3.3 Setting the Voltage.....	12
3.4 Setting the Current.....	13
3.5 Save and Recall Operation	13
3.6 Menu Operation.....	13
3.6.1 Menu Description	13
3.6.2 Menu Function	15
3.7 Output Operation.....	20
3.8 Remote Sense and digital port functions	20
3.9 Digital Volt Meter (DVM).....	21
3.10 Milliohm Meter	22
4. Remote Operation.....	23
4.1 Communication cable.....	23
4.2 Communication between Power Supply and PC.....	24
4.3 SCPI Command Overview	25
Common IEEE488.2 Commands	25
Essential SCPI Commands.....	26
Port Configuration Command	27
Trigger Commands.....	28
SCPI Condition Register	28
4.4 SCPI Command Description	30
Common IEEE488.2 Commands	30
Essential SCPI Commands.....	33
Output Commands.....	36
List File Commands	37
Measurement commands.....	39
Interface Configuration Commands	41
Trigger commands.....	42
Calibration commands.....	42
5 Specifications.....	44
5.1 Specifications	44
5.2 Supplemental Characteristics	46

1. Introduction

Description

Models 9120A, 9121A, 9122A, 9123A and 9124 are fully programmable, linear DC Power Supplies that provide you with clean and reliable power, high resolution and accuracy combined with fast transient response times and excellent temperature stability. The front panel keys and the control knob provide a convenient interface for adjusting Voltage and Current, storing and recalling operating states or enabling/disabling the output. This power supply is suitable for either bench or rack mounted operation. The 912x is a compact, laboratory grade power supply well suited for applications in design, production or use in university labs.

Features

- Very high accuracy and resolution: 0.1mV, 0.1mA
- Low ripple and low noise
- Fast settling time < 20ms
- $5\frac{1}{2}$ digit digital voltage meter and $m\Omega$ meter
- Convenient data entry via knob or numerical key pad
- Over Temperature (OTP) protection
- Compact foot print (2U x 1/2)
- Bright and easy to read display (VFD technology)
- Excellent temperature stability
- Output on/off control
- SCPI compatible command set. Communicate via USB, RS232 or GPIB (model 9123A only) interface
- Application Software for front panel emulation and simple test sequence generation
- Rack mount kit available
- Closed case calibration
- Remote Sense Function
- Discrete Fault Indicator/Remote Inhibit (DFI/RI). Can be used to turn off power supplies simultaneously.
- List Mode: Generate, store and execute test sequences without the need for an external computer

2. Quick Reference

2.1 The Front Panel

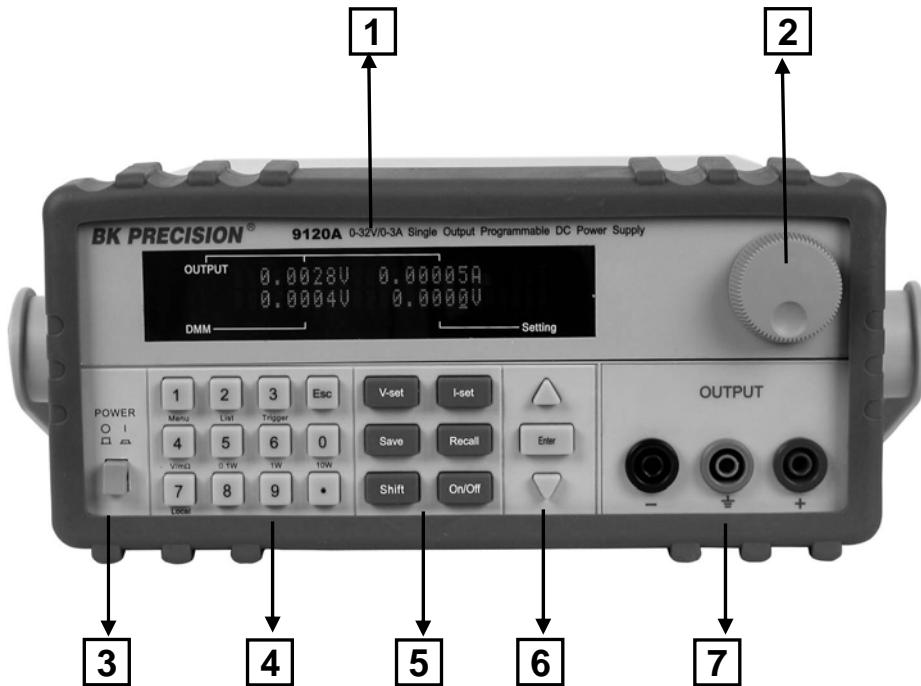

- 1** VFD display
- 2** Rotary knob
- 3** Power switch
- 4** Numeric keys, auxiliary functions
- 5** Function keys
- 6** Up/Down keys and "Enter" key
- 7** Output terminals

2.2 The Rear Panel

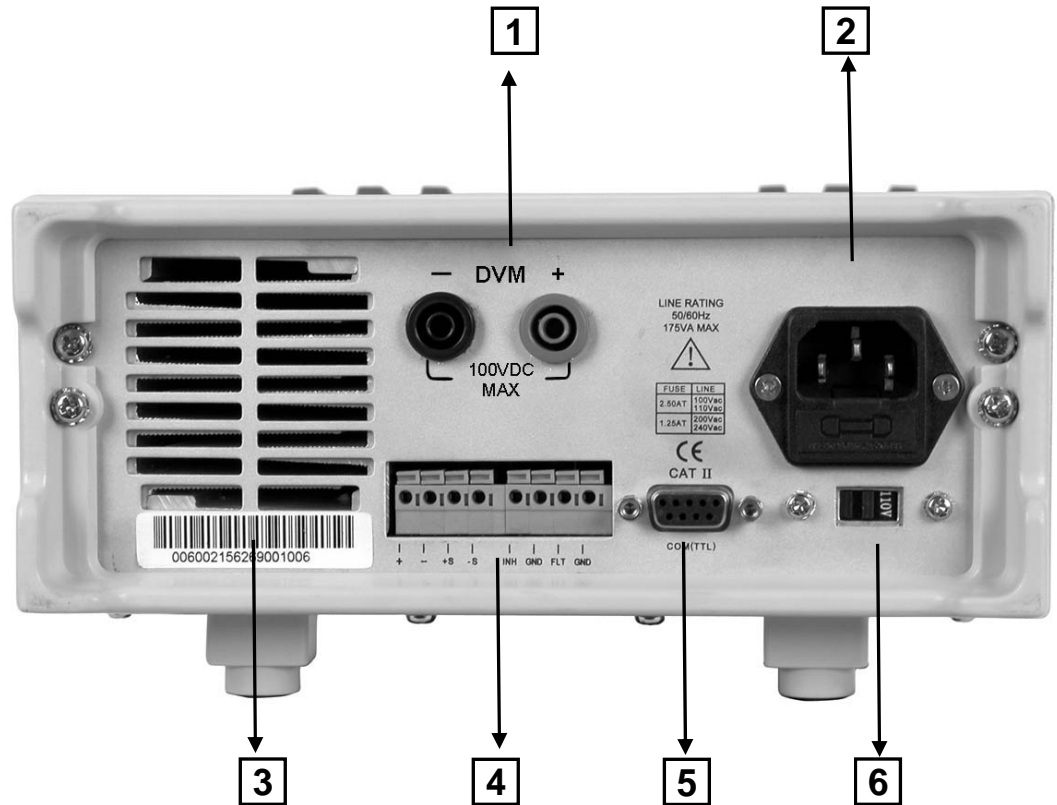

- 1** Digital Voltmeter terminals
- 2** AC power inlet and fuse compartment
- 3** Ventilation holes
- 4** Quick connect terminal for Remote sensing and digital port functions (digital I/O, DFI/RI and ext. trigger)
- 5** TTL interface connector for remote control
- 6** AC Power selection switch (110V / 220V)

2.3 Preliminary Checkout

The following steps help you verify that the power supply is ready for use.

1. Check the list of supplied items

Verify that you have received the following items with your power supply. If anything is missing, contact your authorized B+K Precision distributor.

- Power cord
- Instruction manual
- Calibration Report
- Communication cable
- Installation disk

2. Connect the power cord and turn on the power supply

When you turn on the power supply, the front-panel display will light up briefly while the power supply performs its power-on self-test. All the VFD annunciators will turn on at once. Check for any missing display segments. Refer to section 1.5 in this chapter, if the power supply does not turn on.

3. Checkout Procedure

At power up, the instrument will automatically perform a self test routine. During this time, the following should be displayed:

System Test, Please wait!
■■■

followed by

0.000V 0.00000A
0.000V 0.000V

The first row displays the actual output voltage value and current and the state of power supply. The second row displays the voltage measured by the DVM (on left) and the Set Value for the voltage of the power supply.

To obtain additional information about the instrument, press and hold the SHIFT button during Power Up. On the display you will see the following:

First row: V/A rating and DVM voltage range

second row: Firmware version and serial number

Sourc: XXV XA Meas: XXV
Ver: 1.67 SN:5975002002

Press “Esc” to exit, VFD displays as follows:

In case the self test routine is not successful, you may see one of the following:

If the EEPROM was damaged or the latest operation data is lost, the VFD will display:

ERR EEPROM

If the calibration data stored in the EEPROM is lost, the VFD will display

ERROR CAL

If the latest operating state of the power supply in EEPROM is lost, the VFD will display:

Error Config Data



Warning: The power supply is shipped from the factory with a power-line cord that has a plug appropriate for your location. Your power supply is equipped with a 3-wire grounding type power cord; the third conductor being the ground. The power supply is grounded only when the power-line cord is plugged into an appropriate receptacle. Do not operate your power supply without adequate cabinet ground connection.

1.4 Output Verification

The following procedures verify that the power supply outputs the correct voltage and current levels and properly responds to entries from the front panel.

Voltage Output Check

The following steps verify basic voltage functions without load.

1) Turn on the power supply.

2) Enable the outputs

Press the **Out on/off** key. Notice the CV annunciator turning on.

3) Set the voltage value

Set a different voltage values. Make sure that the set value and output value are the same. Also check if the output current value is zero or close to zero A.

4) Ensure that the voltage can be adjusted from zero to the maximum rated value.

Current Output Check

The following steps check the basic current functionality by shorting the power supply's output.

1) Turn on the power supply.

2) Disable the output by pressing the **Out on/off**. The ON annunciator is turned off.

3) Connect a short across the (+) and (-) output terminals with an insulated test lead. Use a wire size sufficient to handle the maximum current.

4) Enable the output.

5) Adjust the voltage value to 1.0 volt. Ensure that the that he CC annunciator is lit (power supply is in CC operation mode)

6) Adjust the current value. Set a different Current value and check if the actual Current value is the same as the set Current value. Also verify that the output voltage value is nearly zero.

7) Ensure that the current can be adjusted from zero to the full rated value.

8) Turn off the power supply and remove the short wire from the output terminals.

1.5 If the power supply does not turn On

Use the following steps to help resolve problems you might encounter when turning on the instrument.

1. Verify that there is AC power applied to the power supply.

Verify that the power cord is firmly plugged into the power receptacle on the rear panel of the power supply. Make sure the power outlet you are using is working properly and verify that the power supply is turned on.

2. Verify the power-line voltage setting.

Make sure the voltage selector switch is set according to the present line voltage (110VAC or 220VAC). Change the voltage setting if it's not correct.

3. Verify that the correct power-line fuse is installed.

Model	Fuse Description(110VAC)	Fuse Description (220VAC)
9120A	T2.5A 250V	T1.25A 250V
9121A	T2.5A 250V	T1.25A 250V
9124	T2.5A 250V	T1.25A 250V
9122A	T3.15A 250V	T1.5A 250V
9123A	T3.15A 250V	T1.5A 250V

Replace blown fuses according to the table above.

1.6 Adjusting the Carrying Handle

To adjust the position, grasp the handle by the sides and pull outward. Then rotate the handle to the desired position.

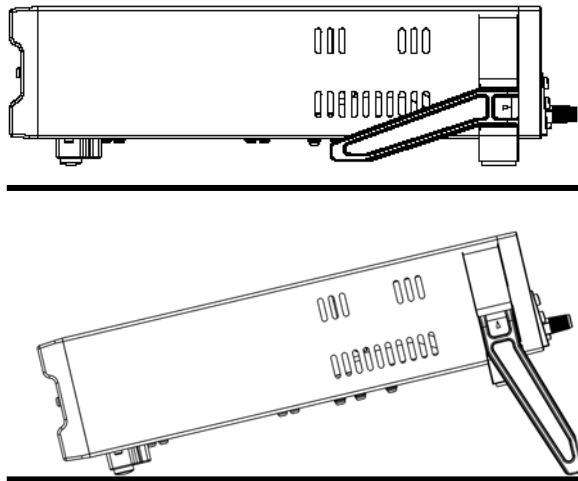

Bench-top viewing positions

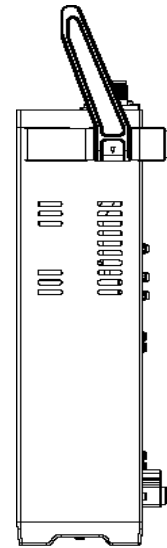

Carrying position

1.7 Rack Mounting the Instrument

You can mount the power supply in a standard 19-inch rack cabinet using the IT-E151 rack mount kit.

Note: Remove the carrying handle and the two plastic ears before rack-mounting the instrument. To remove the handle, grasp the handle on the side, pull outwards and rotate it to a special position where the arrow on the handle and the arrow on the plastic ears are in opposite directions. Now you can pull the handle outwards. After removing the handle, you can remove the two plastic ears with a screw driver.

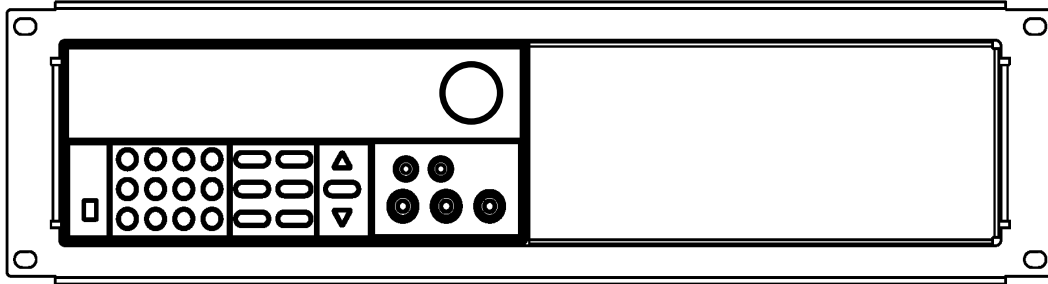

To rack mount a single instrument, order rack mount kit IT-E151

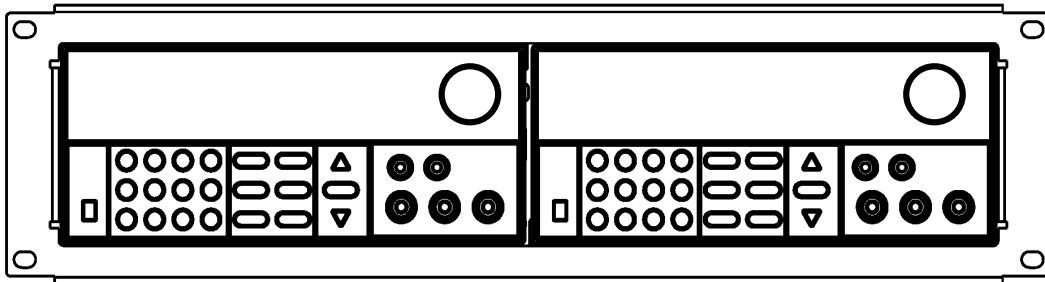

To rack mount two instruments side-by-side, order rack mount kit IT-E151, In this case you don't need to use the front cover panel.

3. Front-panel Operation

So far we have covered the quick start chapter which briefly introduced the front panel operation and how to check basic voltage and current functionality. This chapter describes in detail how to operate the instrument manually via the front-panel keys.

This chapter is divided into the following sections:

- Front-Panel Operation Overview
- Setting the Voltage
- Setting the Current
- Save/Recall Operation
- Menu Operation
- On/Off Operation
- Remote Sense and digital port functions
- $m\Omega$ Meter
- Digital Voltage Meter

3.1 Front Panel Keys

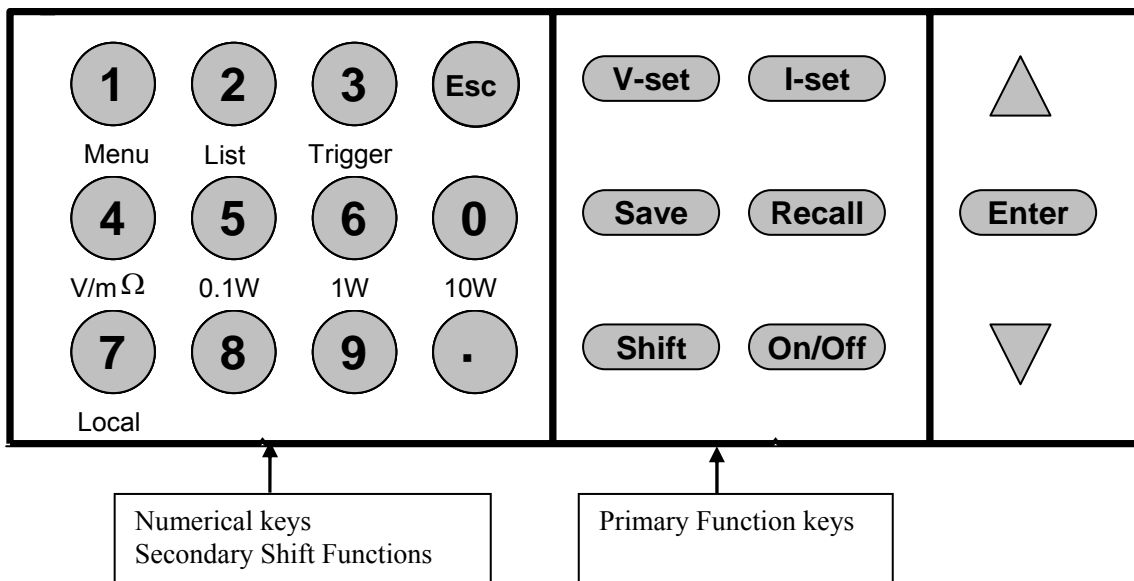



Numerical Keys/Secondary Shift Functions

Shift Functions

- V/m Ω : Toggle between DVM and $m\Omega$ Meter mode
- 0.1W: Set the range of the $m\Omega$ Meter to 0.1W
- 1W: Set the range of the $m\Omega$ Meter to 1W
- 10W: Set the range of the $m\Omega$ Meter to 10W
- Menu Set the parameters of the power Supply
- List Generate programs in List Mode
- Trigger Generate a single trigger pulse (when configured for Immediate mode)
- Local Enable front panel operation when in remote mode
- 0 – 9 Numerical keys for direct entry of values

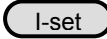
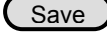
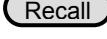
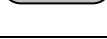
Primary Function Keys

	Set the voltage value
	Set the current value
	Save the current operating data to internal memory
	Recall operating data from internal memory
	Set the output state of the power supply
	Use to access secondary functions

Up/Down and Entry key

▲ : Up key

▼ : Down key

Enter: Press to confirm numerical entries

3.2 Front-panel Operation Overview

- 1) The power supply at shipment is preconfigured for front-panel operation. At power-on, the power supply will automatically start up in front panel operation mode.
- 2) When the power supply is in remote operation mode, the front-panel is disabled. You can revert to Local mode, by pressing the Local button or by sending the appropriate SCPI command. Toggling between front-panel and remote operation modes will not result in any change of the output parameters.
- 3) The output of the power supply can be enabled or disabled from the front panel by pressing the  key. When the output is on, the CV or CC annunciator will turn on.
- 4) The VFD annunciators display the present operating status of the power supply. At power up, the following is displayed: The top row shows the actual output voltage and output current value and the state of the power supply. The second line shows the voltage value as measured by the DVM and the Set value of the Voltage. The bottom right field is also used to display the Current Set Value, the Menu parameters and the Ohm meter range.

3.3 Setting the Voltage

The Voltage can be adjusted from 0V to the maximum rated voltage of each model. There are 2 ways to set the constant voltage value.

Solution1 :

Press the ▲ and ▼ keys or the knob to change the value of the least significant digit

Solution2:

1. Press **V-set**
2. Use the numeric keys **0** to **9** and confirm your entry by pressing **Enter**

3.4 Setting the Current

The Current output is adjustable from 0A to the maximum current value of each model.

1. Press **I-Set**
2. Enter a numerical value or use the **▲** and **▼** keys to change the current value
3. Press **Enter** to confirm the value

3.5 Save and Recall Operation

You can store up to 50 different operating states in memory locations 1 through 50. Each operating state includes a constant voltage value, constant current value, maximum output voltage value and voltage step value.

To save a setting:

Set the desired Voltage and Current value

Press the save **Save** key. Use the knob to scroll to one of the memory locations 1 – 50. Press **ENTER** to assign and store the current settings to the selected memory location

To recall a setting:

Press the Recall key. Use the knob to scroll to the memory location where the settings you want to recall are stored. Press **ENTER** to recall and activate those settings

You can also use the SCPI command: *SAV, *RCL to save and recall.

3.6 Menu Operation

3.6.1 Menu Description

Press Shift :Menu to enter menu mode. The menu parameters will be displayed in the bottom right field of the display. Use the **▲** and **▼** keys to scroll through the menu list and press **ENTER** to select a menu and view the parameters. Press **ESC** to return to the higher level menu and to return to the main operating mode.

MENU		
Config		
	Config Init.	Return to the factory default setup value.
	Out Recall	Set the Power ON/OFF state after power up.
	On	“Remembers” and restores the Power ON/OFF state of the power supply before power was turned off.
	Off<Default>	Disable this function.
	PWR-ON Recall	Recall operating parameters of power supply after power up
	On	“Remembers” and restores the operating parameters of the power supply (voltage, current settings..) before power was turned off.
	Off<Default>	Disable this function.
	Key Sound Set	Keypad sound setting.
	On<Default>	Enable key sound.

	Off	Disable key sound
	Knob Lock Set	Enable/disable the rotary knob.
	On	Lock the rotary knob.
	Off< Default >	Unlock the rotary knob.
	Remote Sense	Setup voltage measurement Mode.
	On	The power supply will measure the input voltage at the remote sense connector.
	Off< Default >	The power supply will measure the input voltage at the front panel connector.
	ShortCut Recall	Shortcut of the recall function
	On	Enable this function
	Off<Default>	Disable this function
	Meter Rate Set	Set the update speed of the power supply meter
	High	High speed
	Low< Default >	Low speed
	Baudrate set	Set the baud rate
	Baudrate 4800 < Default >	
	Baudrate 9600	
	Baudrate 19200	
	Baudrate 38400	
	Comm. Parity	Configure the parity bit.
	None< Default >	
	Even	
	Odd	
	Address Set	Set the communication address (range from 0 to 30)
	Address= * *	
	Port Mode	Select mode of digital port
	Trigger< Def >	
	RI/DFI	
	DIGITAL I/O	
	Trig Source	Setting the trigger mode
	Immediat<Def>	Pressing Shift + Trigger keys will generate a trigger pulse
	External	Ext. Trigger signal is applied to the digital port in the rear panel.
	Bus	Remote command trigger mode.
	RI Mode	Configure the Remote Inhibit (RI) mode
	Off< Default >	Disable this function
	Latching	
	Live	
	DFI Source	Configure the Discrete Fault Indicator (DFI) mode
	Off< Default >	
	QUES	Question Bit
	OPER	Operation Bit
	ESB	Event State Bit
	RQS	Require Bit
	Key Lock Set	Setting keypad password. Press Enter directly to disable the key lock function.
	Password= * * * *	
	Exit	

System Set		
	Max Volt. set	Set the Maximum Voltage.
	Max= * * * *	
	Step Volt Set	Set the voltage step
	Step= * * * *	
	Exit	
List Set		Configure list files
	Call ListFile	Recall list operation file.
	Edit ListFile	Edit list operation file.
	Continuous	
	Once	
	Repeat	
	Step	
	Once	
	Repeat	
	Save Mode Set	Users can allocate 4 types of memory space to save the list file.
	8 X 25 Steps	
	4 X 50 Steps	
	2 X 100 Steps	
	1 X 200 Steps	
	Exit	
Out On Timer	Output timer. If Timer State is set to ON, power supply output will turn off after the timer elapsed.	
	Timer State	Setting POWER ON timer state
	On	Enable Output Timer. Output will turn off after value set in menu "Timer Set" counted down to zero.
	Off< Default >	
	Timer Set	Setting time of POWER ON timer.
	Timer= * * S	
	Exit	
Exit		

3.6.2 Menu Function

ShortCut Recall

This parameter enables a Shortcut version of the Recall functionality available by pressing the Recall button (see 3.5)

To enable this function, do the following:

- 1) Press **Shift** + **MENU** When Config is displayed, press **ENTER**
- 2) Press **▲**、**▼** to scroll to ShortCut Recall then press **ENTER**
- 3) Press **▲**、**▼** to turn this feature On , press **ENTER** to confirm.
- 4) Press Esc twice to exit from the menu

Now you can conveniently recall up to 9 settings by simply pressing one of the corresponding number keys 1 – 9. The setting previously stored at that location, (using the Save function), will be retrieved and activated. If the selected location is empty, EEPROM ERROR will be displayed.

Setting the Baud Rate (>BAUDRATE)

This parameter configures the baud rate for serial communication. Possible values are 4800, 9600, 19200 or 38400. When operating the power supply in remote mode, make sure that you configure identical baud rate settings for the power supply and the computer. The default setting is 4800.

Setting Address (>ADDRESS)

With this parameter, it is possible to address each instrument. The address range is 0 to 30. The default address is zero.

Port Mode

A 4-pin connector in the rear panel is provided for digital input and output signals. This digital port can be configured to provide Fault/Inhibit, External Trigger or Digital I/O functions. The signal level is TTL.

TRIGGER: Pins 1 and 2 can be used to apply external trigger sources to the power supply. These pins can also be used to control the list operation

RI/DFI : The Inhibit Input pin can be used to control the output state of the power supply (RI function). The Fault Output pin (DFI function) can be used to indicate internal faults of the power supply.

DIGITAL I/O : Read and control output and input state of the 2 available pins.

Pin \ Mode	Trigger	RI/DFI	DIGITAL I/O
1	Trigger in	Inhibit Input	Digital Input
2	GND	GND	GND
3	No Use	Fault Indicator Output	Digital Output
4	No Use	GND	GND

Trigger Operation

The power supply supports 3 different trigger modes. Immediate, External and Bus. Configure one of the trigger sources before performing trigger operating.

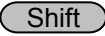
- Trigger Key:
When this function is enabled, you can generate an immediate trigger pulse by pressing  Trigger.
- External trigger signal (TTL):
When this function is enabled, the power supply can be triggered with a TTL pulse applied to pin 1 of the terminal connector in the rear. The TTL on pulse width should be at least 5 ms.
- Bus
When this function is enabled, you can trigger the power supply by sending a *TRG or TRIGGER command to the power supply

Remote Inhibit (RI) - Input

Used to turn off the output of the power supply. Can be used to turn off several power supplies simultaneously.

The RI input has 3 modes: LATCHING, LIVE and OFF

- LATCHING** When the TTL signal at the RI port transitions from TTL High to Low, the output of the power supply will turn off.
- LIVE** The output state of the power supply changes according to the signal level applied to the RI port. If the level is TTL high, the power supply output is on; if the level at the RI port is TTL Low, the output of the power supply is off.
- OFF** The signal applied to the RI port does not affect the output state of the power supply.

Discrete Fault Interupt (DFI) - Output

Used to indicate that a fault has occurred in power supply.

The DFI function can be activated by state changes of the QUES, OPER, ESB, RQS bits

- QUES :** The output level of DFI reflects the state of the QUES bit. When the QUES bit is 1, the DFI output goes to a low level. When QUES bit is 0, DFI the output goes High
- OPER :** The output level of DFI reflects the state of the OPER bit.
- ESB :** The output level of DFI reflects the state of the ESB bit.
- RQS :** The output level of DFI reflects the state of the RQS bit.
- OFF :** The output level of the DFI port remains high.

KEY LOCK

It is possible to set a password to lock the function keys. After setting the password, all the function keys on the front panel will be locked except the OUT On/Off key. You must enter the correct password to enable the keys again. If you don't want to lock the function keys and you selected the >KEY LOCK menu, simply pres the Enter key, do NOT enter any numbers

When shipped from the factory, no password is set and the function keys are unlocked. The start bit of your desired password shouldn't be 0.

List Set

This mode allows you to create a sequence of steps, store it into the power supplies non volatile memory and execute it. The input parameters for generating a list include the name of the list file, the input steps (no more than 200 steps), the step time (the minimum is 1mS) and the value of each step. The list file can be stored in ROM with a capacity of 4K from where it can be recalled. This memory area is divided into 4 areas A, B, C, D. Each area can store a certain amount of groups, and each group has an assigned maximum capacity according to the table below:

Memory area	Number of groups/ area	Capacity/group
A	1	4 KByte
B	2	2 KByte
C	4	1 KByte
D	8	512 Byte

Example: Group C con store 4 groups, each group has a maximum capacity of 1 KByte.

The power supply executes a list in CONTINUOUS or Step mode. In CONTINUOUS mode, the power supply will start executing the list once, as soon as a trigger signal is received, then it will wait until the next trigger signal is received.

Before you edit the list file, set the trigger source in the menu to “immediate”.

Example:

- 1) Press **Shift** +
- 2) Press up or down key to select “Config”, press **Enter** to confirm.
- 3) Press up or down key to select “Trig Source”, press **Enter** to confirm.
- 4) Press up or down key to select “Immediat”, press **Enter** to confirm.

Memory area	Number of groups/ area	Capacity/group
A	1	4 KByte
B	2	2 KByte
C	4	1 KByte
D	8	512 Byte

Example: Group C can store 4 groups, each group has a maximum capacity of 1 KByte.

The power supply executes a list in CONTINUOUS or Step mode. In CONTINUOUS mode, the power supply will start executing the list once, as soon as a trigger signal is received, then it will wait until the next trigger signal is received.

Operation :

Generate file: 2 cycles, continuous mode

- 1) Press **Shift** + **Menu** into menu operation.
- 2) VFD displays Config , press ▼ to select List Set , press **Enter** to confirm.
- 3) VFD displays Call ListFile , press ▼ to select Edit ListFile, press **Enter** to confirm.
- 4) VFD displays Continuous , press **Enter** to confirm.
- 5) VFD displays Repeat , press **Enter** to confirm
- 6) VFD displays Second, Select ms then press **Enter** to confirm
- 7) VFD displays List Count= _ ,press numeric key or move the rotary knob, set number of cycles (in this example, count is 2) , press **Enter** to confirm.
- 8) VFD displays 1th= * . * * * V, press numeric key or move the rotary knob, set the maximum voltage, press **Enter** to confirm.
- 9) VFD displays 1th= * . * * * A, press numeric key or move the rotary knob, set the maximum current, press **Enter** to confirm.
- 10) VFD displays 1th= * mS, press numeric key or move the rotary knob, set delay time, press **Enter** to confirm.
- 11) VFD displays 2th= * . * * * V, press numeric key or move the rotary knob, set the maximum voltage, press **Enter** to confirm.
- 12) VFD displays 2th= * . * * * A, press numeric key or move the rotary knob, set the maximum current, press **Enter** to confirm.
- 13) VFD displays 2th= * mS , press numeric key or move the rotary knob, set delay time, press **Enter**

to confirm.

- 14) VFD display Store File_ press numeric key or move the rotary knob, set the register number(1 to 8), press **Enter** to confirm.
- 15) Press **Esc** two times to escape menu operation.

Execute file

- 16) Press **Shift** + **List** to set the list file, then press **Shift** + **Trigger** to run the list file. Press **Shift** + **List** to stop.

If you have created several list files, you can call the list file that you need by “Call ListFile” function in the menu. Press **Esc** two times to exit menu operation. And then press **Shift** + **List** to set it, press **Shift** + **Trigger** to run the file that you called. Press **Shift** + **List** to stop running.

Continuous mode: Once the trigger signal is received, the programmed list will be executed once. Once finished, the instrument will pause until the next trigger signal is received.

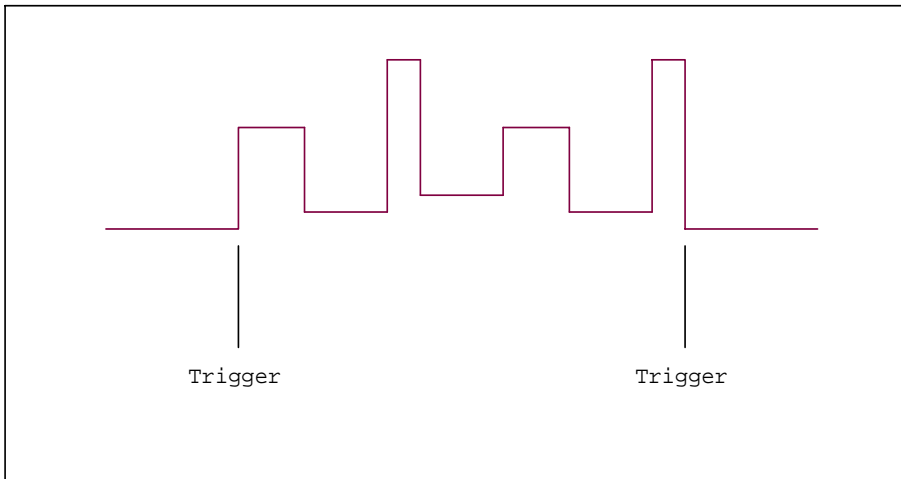

Step mode: The power supply will advance to the next step only after it receives a trigger signal.

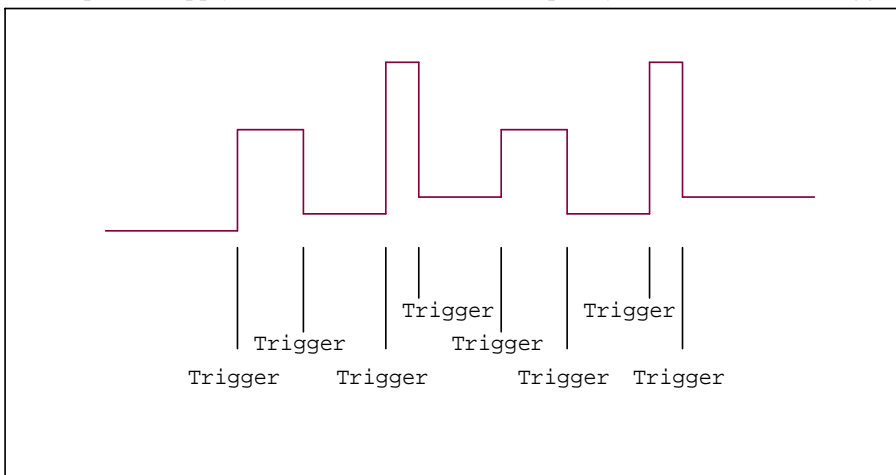

Digital I/O

When the digital port of the power supply mode is in DIGITAL I/O mode and the power supply is configured for remote operation, you can send SCPI command (DIGital:INPut[:STATE?] and DIGital:OUTPut[:STATE?]) to

read and set the state of the output and input port.

3.7 Output Operation

For front panel operation, press **On/Off** to enable/disable the output. If the power supply is in remote control mode, you can send SCPI command (OUTPut ON|OFF) to change the state of output.

3.8 Remote Sense and digital port functions

8 pin connector in rear panel

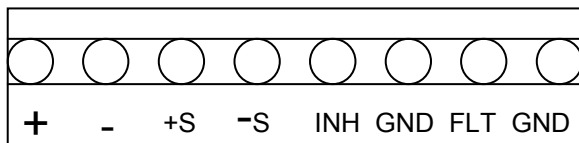

+S,-S Remote sense pins

Remote voltage sensing is used to maintain good regulation at the load and reduce the degradation of regulation that would occur due to the voltage drop in the leads between the power supply and the load. By connecting the supply for remote voltage sensing, voltage is sensed at the load rather than at the supply's output terminals. This will allow the supply to automatically compensate for the voltage drop in the load leads and improve regulation.

You must set remote sense mode before you start remote test function.

+,- Output pins

These pins are identical to the out put terminals in the front

INH Inhibit Input pin

This pin has multiple functions:

a) When “Port Mode” in the menu is set to “Trigger”, INH is configured as trigger Input.

b) When “Port Mode” in the menu is set to “RI/DFI”, INH can be used to turn the power supply output on/off.

INH can be configured in 3 ways:

LATCHING : When the level of INH port changes from high to low, the output of power supply turns off.

LIVE : The output state of power supply changes according to the level of the INH port. If the level of INH is TTL High, the output is on. If the level at pin INH is TTL Low, the output of the power supply is off.

OFF : The level state of INH does not affect the output state of the power supply.

c) When “Port Mode” in the menu is set to “DIGITAL I/O”, INH port functions as a digital input pin. The status of the pin can be read via SCPI command

FLT: Fault Output pin

This pin hat multiple functions:

a) When “Port Mode” in the menu is set to “Trigger”, FLT has no function.

b) When “Port Mode” in the menu is set to “RI/DFI”, the FLT pin can be used to determine the reason of a power supply fault.

The status of FLT can be derived from bits QUES, OPER, ESB, RQS or it can be disabled

QUES : The output level of FLT reflects the state of the QUES bit. When the QUES bit is 1, FLT output a

Low signal, otherwise, if QUES bit is 0, FLT goes High.

OPER : The output level of FLT reflects the of the OPER bit.

ESB : The output level of FLT reflects the state of the ESB bit.

RQS : The output level of FLT reflects the state of the RQS bit.

OFF : The output level of FLT remains high.

c) When “Port Mode” in menu is set to “DIGITAL I/O”, FLT functions as an output pin. The status of the port can be programmed via SCPI command.

3.9 Digital Volt Meter (DVM)

The power supply provides a built-in Digital Volt meter which can measure DC volts in a range from 0 - 40V.

The connectors are in the rear panel. The voltage value is displayed on the bottom left field of the display.

To measure voltages, connect the leads as shown here:

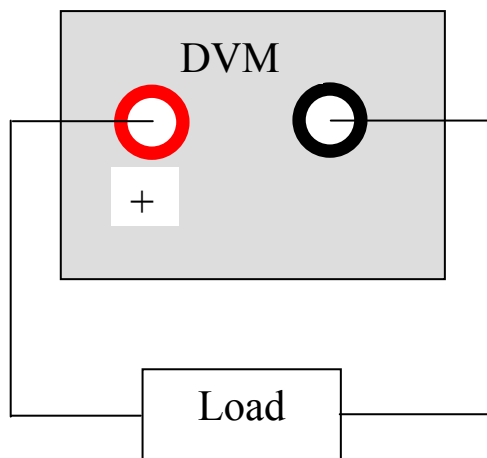

By default, the power supply is in DVM mode. Press **Shift** followed by $V/m\Omega$ to toggle between Voltmeter and $m\Omega$ Meter mode.

3.10 Milliohm Meter

The instrument is also equipped with a Milliohm Meter which can accurately measure resistance up to 10Ω . To protect the resistor, make sure to select an appropriate power range before connecting it to the power supply. To measure resistance, connect the resistor as shown below:

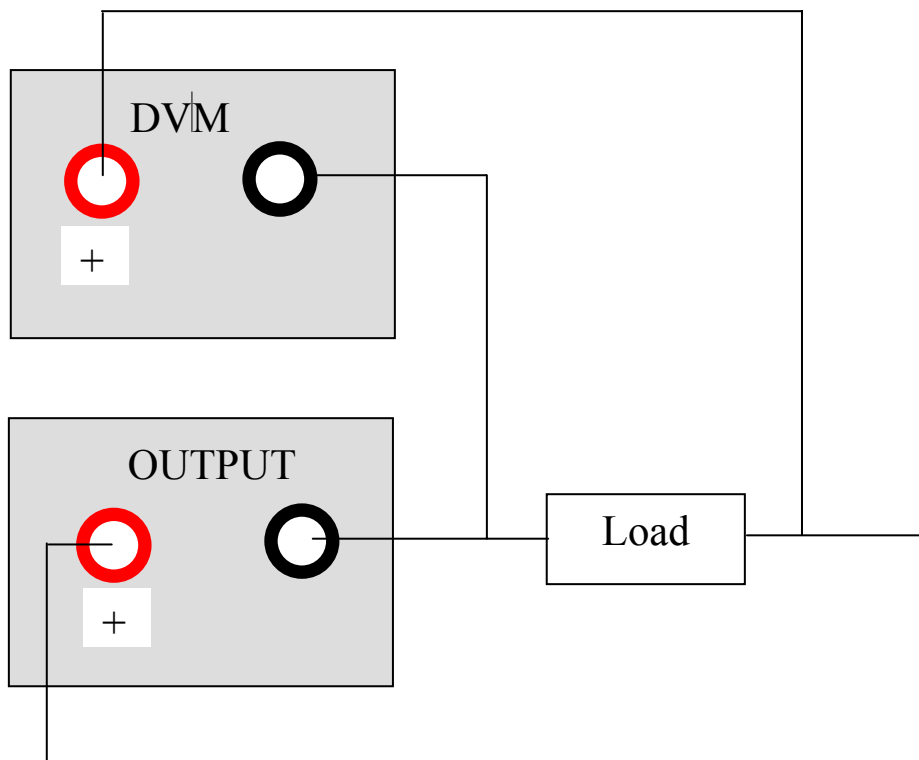

To measure resistance:

- 1) Enable Ohmmeter mode: Press **Shift** followed by $V/m\Omega$ (Display will show ---.--- $m\Omega$ Range 0.1W)
- 2) Press **Shift** followed by 0.1W /1W /10W to select an appropriate range for the resistor you are measuring.

Measurement range	0.1W	1W	10W
Test voltage (Output)	1V	3.3V	10V

4. Remote Operation

The DB9 TTL interface connector on the rear panel of the power supply can be connected to a RS-232, USB or GPIB (model 9123A only) interface via a serial converter cable. This chapter describes how to use a computer to control the output of the power supply.

4.1 Serial adapter cables

RS232 to TTL serial Converter cable IT-E131 (standard)

The DB9 interface connector on the rear panel of the power supply provides a TTL level interface. Use the communication cable (IT-E131) to connect the DB9 interface connector of the power supply to the RS-232 interface connector of the computer

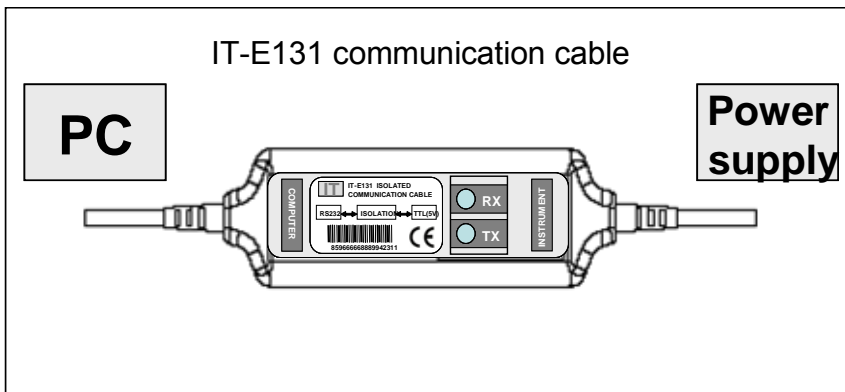

Note: It is **not possible** to connect the DB9 TTL connector on the power supply's rear panel supply via a standard RS232 cable to a PC's RS232 port.

USB to TTL serial Converter cable IT-E132 (option)

The DB9 interface connector on the rear panel of the power supply provides a TTL level interface. Use the communication cable (IT-E132) to connect the DB9 interface connector of the power supply to the USB interface connector of the computer.

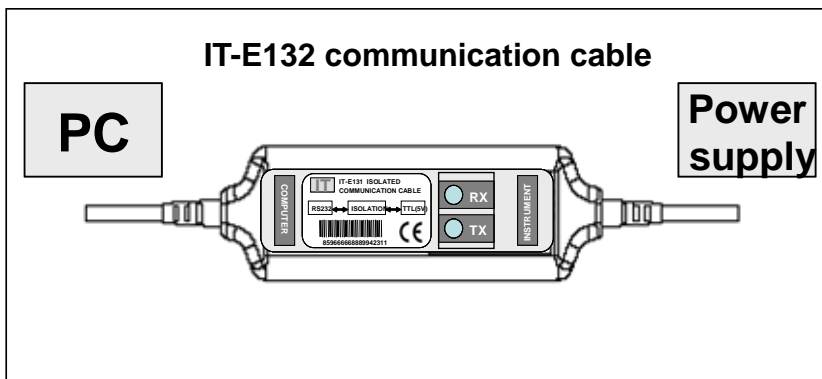

Note: Before you can use the USB communication cable, you must install the USB driver which can be found on the included installation disk.

GPIB to TTL adapter IT-E135

The DB9 interface connector on the rear panel of the power supply provides a TTL voltage level interface. Use the communication adapter IT-E135 to communicate via GPIB

PC

Connect this side to your computer's GPIB interface (GPIB cable not included)



Power Supply

Connect this connector to DB9 TTL connector of power supply (serial cable included)

Connect external AC power adapter (included)

Recommended power up sequence:

- 1) Connect the IT-E135 adapter to your computer and to the power supply as indicated in the above figure. Connect the external power adapter. Both TX and RX LED should be lit (provided the power supply is turned off)
- 2) Turn on power supply. The TX and RX LEDs will turn off
- 3) For maximum throughput, set the baudrate to 38400. Set parity to NONE (default setting). Set address to the desired GPIB instrument address.

Note: The RX LED and TX LEDs will flicker to indicate activity on the GPIB bus. The RX LED indicates a write command (from controller's perspective), the TX LED will indicate data transmission from power supply to GPIB controller.

4.2 Communication between Power Supply and PC

Before putting the instrument into remote operation, make sure that the baud rate, parity bit and communication address settings on the power supply and computer side are identical, otherwise communication will not be possible.

1. Address Range is 0 to 30. Default setting is 0.
2. Baud rate: 4800,9600,19200 and 38400 are selectable, default setting is 9600
3. Parity and Data bits: None/8 bits (default setting)
 Even/8 bits
 Odd/8 bits
4. Stop bits: 1 (fixed)
5. Start Bits: 1 (fixed)

Data Frame Format

Parity=None	Start Bit	8 Data Bits	Stop Bit	
Parity=Odd, Even	Start Bit	8 Data Bits	Parity Bit	Stop Bit

End of String character is '\n' (0x0a)

DB9 Interface Details

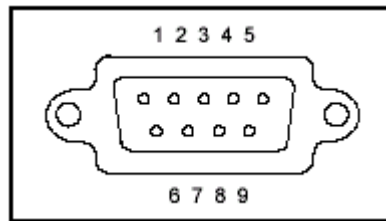

The DB9 connector in the rear panel of the power supply provides a TTL level signal. It can be connected to a standard PC interface via the IT-E131, IT-E132 or IT-E135 isolated converter/adaptor.

Note: Configuration of address parameter

Communication via RS232 and USB: Setting of the address is optional. It is not required to communicate with the instrument. The address can be set from the front panel and is stored in non volatile memory. This feature is useful when communicating via USB, and connecting several instruments, e.g. via a USB hub. In this scenario, Windows assigns a virtual COM port to each device which is unknown prior to establishing communications with the instrument (could be different each time). In this case, the user can correlate each virtual COM port randomly assigned by Windows with a user defined address.

Communication via GPIB: Setting of the address value is mandatory and corresponds to GPIB instrument address according to GPIB/IEEE-488 conventions. Valid values are 0 – 30.

4.3 SCPI Command Overview

Common IEEE488.2 Commands

- *CLS
- *ESE
- *ESE?
- *ESR?
- *IDN?
- *OPC
- *OPC?

*PSC
*PSC ?
*RST
*SRE
*SRE?
*STB?
*TRG
*SAV
*RCL

Essential SCPI Commands

SYSTem

:ERRor[:NEXT]?
:VERSion?,
:ADDRes?
:REMote
:LOCal
:RWLock

STATus

:QUEStionable
 [:EVENT]?
 :CONDition?
 :ENABle <VALUE>
 :ENABle?
:OPERation
 [:EVENT]?
 : CONDition?
 :ENABle <VALUE>
 :ENABle?

Calibration Command

CALibration

:SECure
 [:STATe] {<ON|OFF>,<quoted code>}
 [:STATe]?
:VOLTage
 :LEVel {<level> }
 [:DATA] {<numeric value>}
:CURRent
 :LEVel {<level> }
 [:DATA] {<numeric value>}
:DVM
 :LEVel {<level>}
 [:DATA] {<numeric value>}
:SAVe
:INITial

Output Commands

OUTPut

[:STATe] {<bool>}
[:STATe]?

```

:TIMer
    [:STATe] {<bool>}
    [:STATe]?
    :DATA {<timer>}
    :DATA?

[SOURce:]
MODE {<FIXed|LIST|DRM>}
MODE?
VOLTage
    [:LEVel] {<n>}
    [:LEVel]?
    :PROTection
        :STATe {<bool>}
        :STATe?
        [:LEVel] {<n>}
        [:LEVel]?

CURRent
    [:LEVel] {<n>}
    [:LEVel]?

LIST
    :MODE {<mode>}
    :MODE?
    :STEP {<step>}
    :STEP?
    :COUNt {<n>}
    :COUNt?
    :CURRent
        [:LEVel] {<n>,<n>}
        [:LEVel]? {<n>}
    :VOLTage
        [:LEVel] {<n>,<n>}
        [:LEVel]? {<n>}
    :WIDth {<n>,<n>}
    :WIDth? {<n>}
    :NAME {<string code>}
    :NAME?
    :AREA {1|2|4|8}
    :AREA?
    :SAVe {1|2|3|4|5|6|7|8}
    :RCL {1|2|3|4|5|6|7|8}

```

Input Measure Command

```

MEASure
    [:SCALar]
        :VOLTage[:DC]?
        :CURRent[:DC]?
        :POWer[:DC]?
        :DVM[:DC]?
        :RESistance[DC]?

```

Port Configuration Commands

```

[SOURce:]
SYSTEM
: SENSE [:STATe] {<bool>}

```

```

        [:STATe]?
PORT
    :FUNction {<TRIGger|RIDFi|DIGital>}
    :FUNction?
RI
    :MODE {<OFF|LATChing|LIVE>}
    :MODE?
DFI
    :SOURce {<OFF|QUES|OPER|ESB|RQS>}
    :SOURce?
DIGital
    :OUTPut[:STATe] {<bool>}
    :INPut[:STATe]?
SENSe
    :RESistance:
        :RANGe {LOW | MIDdle | HIGH>}
        :RANGe?

```

Trigger Command

```

TRIGger
    [:IMMediate]
    :SOURce {<source>}

```

SCPI Condition Register

You can obtain the state of the power supply and read parameters from the operation register. The different states of the power supply can be read from 7 condition registers. These registers are status byte register, standard event register, quest condition register and operation status register. The status byte register stores the information of 3 other registers. The following table provides the details on each register's meaning.

BIT	Signal	Meaning
0	CAL	Operation status register The power supply is calculating new calibration parameter.
1	WTG	The power supply is waiting for a trigger signal.
2	CV	The power supply is in constant voltage condition.
3	CC	The power supply is in constant current condition.
4	RI	Show the input level condition of RI
0	OV	Quest condition register Over voltage
1	OT	Over temperature
2	UNR	The output of the power supply is unregulated.
0	OPC	Standard event status register Operation of power supply is completed.
2	QYE	Query error. Data of output array is missing.
3	DDE	Device-dependent error. Data stored in register is missing or error occurs in preliminary checkout.
4	EXE	Execution error. Command parameter overflows or the condition is not right.
5	CME	Command error. Syntax or semantic error occurs when receiving information.
7	PON	Power on. It is 1 when power supply is reset.
3	QUES	Status byte register If a quest enable condition changes, QUES is 1.
5	ESB	If a standard event status enable register changes, ESB is 1.
6	MSS	
	RQS	
7	OPER	If a operation event enable register changes, OPER is 1.

Structure of condition register:

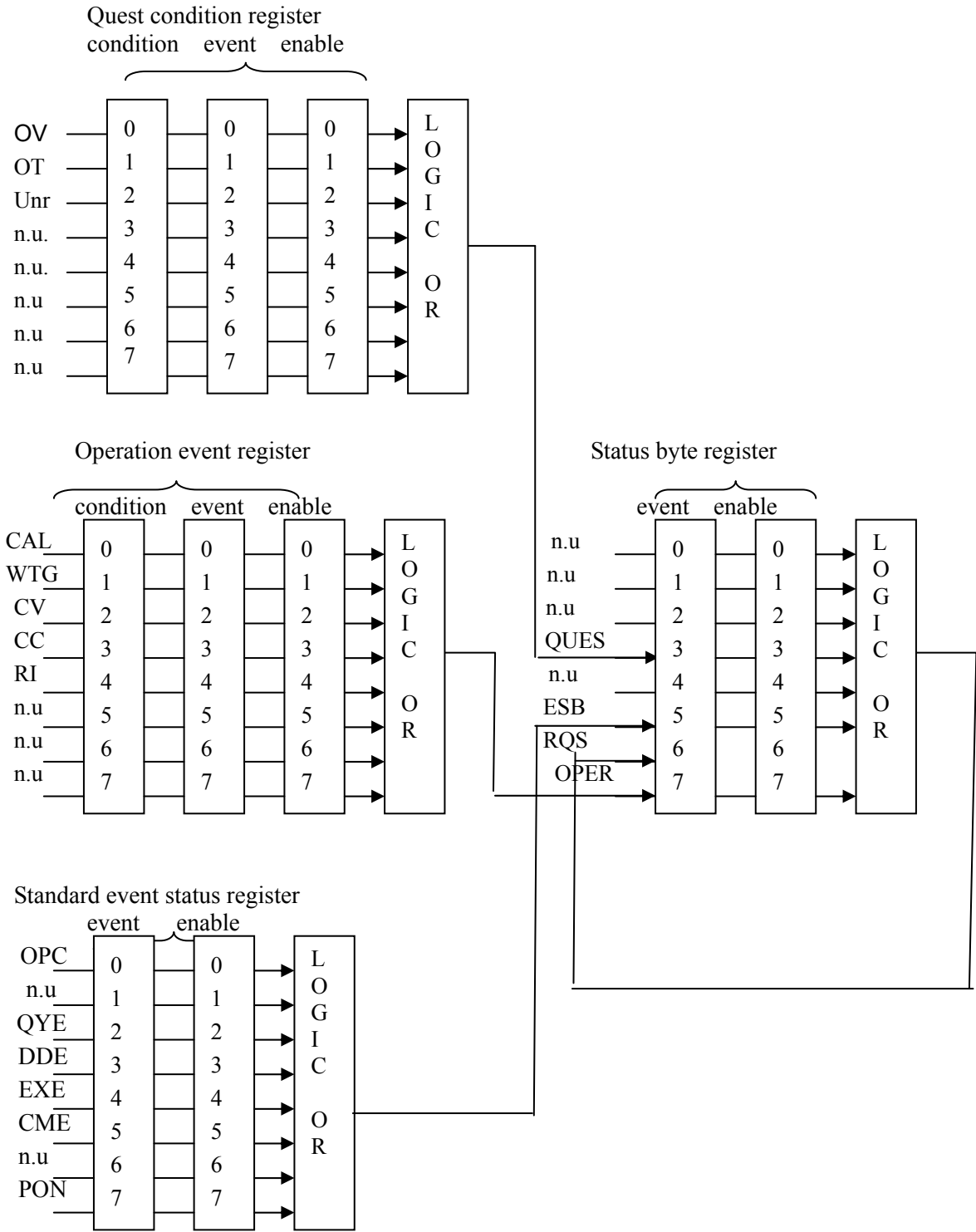

4.4 SCPI Command Description

Common IEEE488.2 Commands

***CLS**

This command clears the following registers:

- ◆ Standard event status register
- ◆ Quest condition register
- ◆ Operation event register
- ◆ Status byte register
- ◆ Error code

Command syntax : *CLS

Parameter : None

***ESE**

This command sets the parameter of the standard event enable register. The value determines which bit value of the standard event register is set to 1. The ESB bit in the of status byte register will change to 1 to reflect the changes.

Command syntax : *ESE <NRf>

Parameter : 0~255

Reset value : Consult *PSC command

Example : *ESE 128

Query syntax : *ESE ?

Return parameter : <NR1>

Reference command : *ESR ? *PSC *STB ?

Bit map of standard event status enable register

Bit position	7	6	5	4	3	2	1	0
Bit Name	PON	Not used	CME	EXE	DDE	QYE	Not used	OPC
Bit Weight	128		32	16	8	4		
PON	Power-on			DDE	Device-dependent error			
CME	Command error			QYE	Query error			
EXE	Execution error			OPC	Operation complete			

***ESR?**

This command queries the standard event status register. After executing this command, the standard event status register is reset. The bit definition of the standard event status register is identical to the standard event status enable register

Query syntax : *ESR ?

Parameter : None

Return parameter : <NR1>

Reference command : *CLS *ESE *ESE ? *OPC

***IDN?**

This command reads information about the power supply. The return value contains 4 segments divided by a comma.

Query syntax : *IDN ?

Parameter : None

Return parameter : <AARD>	segment	description
	BK Precision	manufacturer
	XXXX	product mode
	XXXXXX	product serial number
	VX . XX	software version number

For example : BK PRECISION , 9120A , 000004 , V1.01

***OPC**

When all commands sent to the instrument prior to this command have been executed, OPC of the standard event status register will be set to 1.

Command syntax : *OPC

Parameter : None

Query syntax : *OPC ?

Return parameter : <NR1>

***PSC**

This command controls whether or not the power supply sends when it is reset.

1 OR ON: When power supply is reset, operation event enable register, query event enable register and standard event status register are all reset.

0 OR OFF: The data of status byte register, operation event enable register, quest event enable register and standard event status enable register is stored in nonvolatile register, and is recalled when power supply is reset.

Command syntax : *PSC <bool>

Parameter : 0|1|ON|OFF

Query syntax : *PSC ?

Return parameter : 0|1

Reference command : *ESE *SRE STAT:OPER:ENAB STAT:QUES:ENAB

***RST**

This command resets the power supply to its default setting.

CAL:SEC:STAT OFF
OUTP OFF, CURR MAX
VOLT:PROT:MAX
VOLT: MIN
TRIG:SOUR BUS
SYST:SENS OFF
PORT:MODE TRIG
RI:MODE OFF
DFI:SOUR OFF
VOLT:PROT:STAT OFF

Command syntax : *RST>

Parameter : None

***SRE**

This command can set the parameter of the status byte enable register. The value of this parameter determines which bit value of the status byte register is 1 and the byte will enable RQS of status byte register is 1. The bit definition of the status byte enable register is the same as the status byte register.

Command syntax : *SRE <NRf>

Parameter : 0~255

Reset value : Consult *PSC command

Example : *SRE 128

Query syntax: *SRE ?

Return parameter : <NR1>

Reference Command : *ESE *ESR ? *PSC *STB ?

***STB?**

This command reads data from the status byte register. After executing this command, the status byte register is reset.

Query syntax : *STB ?

Parameter : None

Return parameter : <NR1>

Reference command : *CLS *ESE *ESR

Bit map of the standard event status enable register

Bit Position	7	6	5	4	3	2	1	0
Bit Name	OPER	RQS	ESB	no use	QUES	no use	no use	no use
Bit Value	128	64	32		8			

***TRG**

When the power supply's trigger source is set to Bus command, this command will generate a trigger signal. Its function is identical to the [SYSTEM:]TRIGGER command.

Command syntax : *TRG

Parameter : None

Reference command : TRIG TRIG:SORU

***SAV**

This command saves the operating parameters of the power supply to non volatile memory. The parameters include constant current, constant voltage, maximum voltage value and step voltage values.

Command syntax : *SAV<NRf>

Parameter : 1~50

Example : *SAV 3

Reference command : *RCL

***RCL**

This command recalls the parameter saved with the *SAV command.

Command syntax : *RCL<NRf>

Parameter : 1~50

Example : *RCL 3

Reference command : *SAV

Essential SCPI Commands

SYSTem:ERRor[:NEXT]?

This command queries the error code and error information of the power supply.

(0)	No error
(1)	Too many numeric suffices in Command Spec
(10)	No Input Command to parse
(14)	Numeric suffix is invalid value
(16)	Invalid value in numeric or channel list, e.g. out of range
(17)	Invalid number of dimensions in a channel list
(20)	Parameter of type Numeric Value overflowed its storage
(30)	Wrong units for parameter
(40)	Wrong type of parameter(s)
(50)	Wrong number of parameters
(60)	Unmatched quotation mark (single/double) in parameters
(65)	Unmatched bracket
(70)	Command keywords were not recognized
(80)	No entry in list to retrieve (number list or channel list)
(90)	Too many dimensions in entry to be returned in parameters
(101)	Command Execution error
(100)	Too many command
(110)	Rxd error Parity
1.	Error EEPROM
2.	Config data error
3.	Error Calibration data
4.	Factory Data error

Command syntax : SYST:ERR?

Parameter : None

Return parameter : <NR1> , <SRD>

SYSTem:VERSion?

This command queries the software version.

Command syntax : SYST:VERS?

Parameter : None

Return parameter : <NR2>

SYSTem:ADDRess?

This command queries the address of the power supply

Command syntax : SYST:ADDR?

Parameter : None

Return parameter : <NR2>

SYSTem:REMOte

This command puts the power supply in remote control mode.

Command syntax : SYST:REM

Parameter : None

Query syntax : None

SYSTem:LOCAL

This command configures the instrument for front panel operation

Command syntax : SYST:LOC

Parameter : None

Query syntax : None

SYSTem:RWLOCK[:STATE]

This command also sets the instrument to remote control mode. When using this command, it is not possible to press LOCAL key on the front panel to revert back to manual mode.

Command syntax : SYST:RWL

STATus:QUESTIONable[:EVENT]?

This command queries the parameters of the quest event register. After execution, the quest event register is reset.

Query syntax : STATus:QUESTIONable[:EVENT]?

Parameter : None

Return parameter : <NR1>

Reference command : STATus:QUESTIONable:ENABLE

Bit map of standard event status enable register

Bit Position	7	6	5	4	3	2	1	0
Bit name	no use	no use	no use	no use	no use	unr	OT	OV
Bit Value						4	2	1

STATus:QUESTIONable:CONDition?

This command queries the parameters of the quest condition register. When a bit of the quest condition changes, the corresponding bit value in the quest event register will be set to 1.

Query syntax : STATus:QUESTIONable: CONDition?

Parameter : None

Return parameter : <NR1>

STATus:QUESTIONable:ENABLE

This command sets the parameter of the quest event enable register. This parameter determines which bit of the quest event register is set to 1. If a QUES condition changes, the QUES bit of status byte register will be set to

1.

Command syntax : STATus:QUESTionable:ENABLE <NRf>

Parameter : 0~255

Reset value : Consult *PSC command

Example : STATus:QUESTionable:ENABLE 128

Query syntax : STATus:QUESTionable:ENABLE ?

Return parameter : <NR1>

Reference command : *PSC

STATus:OPERation[:EVENT]?

This command queries the parameters of the operation event register. After executing this command the operation event register is reset.

Query syntax : STATus: OPERation [:EVENT]?

Parameter : None

Return parameter : <NR1>

Reference command : STATus: OPERation:ENABLE

Bit map of standard event status enable register

Bit Position	7	6	5	4	3	2	1	0
Bit Name	no use	no use	no use	RI	CC	CV	WTG	CAL
Bit value				16	8	4	2	1

STATus:OPERation:CONDition?

This command queries the parameters of the operation condition. When a parameter of the operation condition register changes, the corresponding bit in the operation event register will be set to 1.

Query syntax : STATus: OPERation: CONDition?

Parameter : None

Return parameter : <NR1>

STATus:OPERation:ENABLE

This command sets the parameter of the operation event enable register. The parameter determines which bit value of quest event register is set to 1. If a OPER condition changes, the OPER bit of the status byte register will be set to 1.

Command syntax : STATus: OPERation:ENABLE <NRf>

Parameter : 0~255

Reset value : Consult *PSC command

Example : STATus: OPERation:ENABLE 128

Query syntax : STATus: OPERation:ENABLE ?

Return parameter : <NR1>

Reference command : *PSC

Output Commands

OUTPut[:STATe]

This command sets the power supply output on or off.

Command syntax : OUTPut[:STATe] <bool>

Parameter : 0|1|ON|OFF

*RST value : OFF

Query syntax : OUTPut:STATe?

Return parameter : 0|1

OUTPut:TIMer[:STATe]

This command sets the output timer state of the power supply.

Command syntax : OUTPut:TIMer[:STATe] <bool>

Parameter : 0|1|ON|OFF

*RST value : OFF

Query syntax : OUTPut:TIMer[:STATe]?

Return parameter : 0|1

OUTPut:TIMer:DATA

This command sets the time of the output timer.

Command syntax : ONPut:TIMer:DATA <NR1>

Parameter : <NR2>

*RST value : 1

Query syntax : OUPut:TIMer:DATA?

Return parameter : <NR2>

[SOURce:]MODE

This command configures the power supply for command fixed mode, list mode or DVM mode.

FIXed Command fixed mode

LIST List mode

DRM Digital milliohm meter

Command syntax : [SOURce:]MODE <mode>

Parameter : FIXed|LIST|DRM

*RST value: FIXed

Example : MODE FIX

Query syntax : [SOURce:] MODE ?

Return parameter : <CRD>

[SOURce:]CURRENT [:LEVel]

This command sets the current value of the power supply.

Command syntax : [SOURce:]CURRENT [:LEVel] <NRf>

Parameter : MIN TO MAX|MIN|MAX

Unit : A mA

*RST value: MIN

Example : CURR 3A , CURR 30mA , CURR MAX , CURR MIN

Query syntax : [SOURCE:]CURRENT [:LEVEL] ?

Parameter : [MIN|MAX]

Example : CURR ? , CURR ? MAX, CURR ? MIN

Return parameter : <NR2>

[SOURCE:]VOLTage[:LEVel]

This command sets the voltage value of the power supply.

Command syntax : [SOURCE:]VOLTage[:LEVel] <NRf>

Parameter : MIN TO MAX|MIN|MAX

Unit : V mV kV

*RST value : MAX

Query syntax : [SOURCE:]VOLTage[:LEVel] ?

Parameter : [MIN|MAX]

Return parameter : <NR2>

List File Commands

[SOURCE:]LIST:MODE

This command sets the trigger condition for executing the list file

CONTinuous List operation is continuous mode.

STEP List operation is step mode.

Command syntax : [SOURCE:]LIST:MODE <CRD>

Parameter : CONTinuous|STEP

Query syntax : [SOURCE:]LIST:MODE ?

Return parameter : <CRD>

[SOURCE:]LIST:STEP

This command sets the operation mode of the list file.

ONCE List operate once

REPeat Repeat list operation

Command syntax : [SOURCE:]LIST:STEP <SRD>

Parameter: ONCE|REPeat

Query syntax : [SOURCE:]LIST:STEP ?

Return parameter : <CRD>

[SOURCE:]LIST:COUNT

This command sets the number of steps for the list operation.

Command syntax : [SOURCE:]LIST:COUNT <NRf>

Parameter : 2~400

Query syntax : `[[SOURce:]LIST:COUNT ?`

Parameter : None

Return parameter : `<NR1>`

[SOURce:]LIST :CURRENT[:LEVel]

This command sets the current step.

Command syntax : `[SOURce:]LIST:CURRENT[:LEVel]`

Parameter : 0~30A

Unit : A mA

Example : `LIST:CURR 1 , 3A ;`

Query syntax : `[SOURce:]LIST:CURRENT[:LEVel] ?`

Parameter : None

Example : `LIST:CURR ? 1 ;`

Return parameter : `<NR2>`

[SOURce:]LIST :VOLTage[:LEVel]

This command sets the voltage step.

Command syntax : `[SOURce:]LIST:VOLTage [:LEVel] <NRf>`

Parameter : 0~360V

Unit : V mV

Example : `LIST:VOLT 1 , 3V ;`

Query syntax : `[SOURce:]TRANSition: VOLTage:TLEVel ?`

Parameter : None

Example : `LIST:VOLT ? 1 ;`

Return parameter : `<NR2>`

[SOURce:]LIST:WIDth

This command sets the minimum step time.

Command syntax : `[SOURce:]LIST:WIDth <NRf>`

Parameter : MIN TO MAX|MIN|MAX

Unit : S mS

Example : `LIST:WID 1, 100mS;`

Query syntax : `[SOURce:]LIST:WIDth ?`

Parameter : None

Example : `LIST:WID? 1;`

Return parameter : `<NR2>`

[SOURce:]LIST:NAME

This command sets the name for the list file. Make sure the file name does not exceed 8 characters.

Command syntax : `[SOURce:]LIST:NAME <name>`

Parameter : <SRD>

Example : LIST:NAME 'TEST';

Query syntax : [SOURCE:]LIST:NAME?

Return parameter : <SRD>

[SOURCE:]LIST:AREA

This command divides up the storage area for the list file in one of the 4 ways listed below.

- 1 . 1 group per store area, 400 steps
- 2 . 2 groups per storage area, each group contains 200 steps.
- 4 . 4 groups per storage area, each group has 100 steps.
- 8 . 8 groups of storage area, each group has 50 steps.

Command syntax : [SOURCE:]LIST:AREA <NR1>

Parameter : 1|2|4|8

Example : LIST:AREA 1

Query syntax : [SOURCE:]LIST:AREA ?

Return parameter : <NR1>

[SOURCE:]LIST:SAVe

This command saves the list file to a register (non volatile memory).

Command syntax : [SOURCE:]LIST:SAVe <NR1>

Parameter : 1~8

Example : LIST:SAV 1

[SOURCE:]LIST:RCL

This command can recall the list file saved before from the register.

Command syntax : [SOURCE:]LIST:SAV <NR1>

Parameter : 1~8

Example : LIST:SAV 1

Measurement commands

MEASure[:SCALar]:VOLTage[:DC]?

This command queries the input voltage of the power supply.

Command syntax : MEASure[:SCALar]:VOLTage[:DC]?

Parameter : None

Return parameter : <NR2>

Return parameter unit : V

Example : MEAS:VOLT ?

MEASure[:SCALar]:CURRent[:DC]?

This command queries the input current of the power supply.

Command syntax : MEASure[:SCALar]:CURRent[:DC]?

Parameter : None

Return parameter : <NR2>

Return parameter unit : A

Example : MEAS:CURR ?

MEASure[:SCALar]:POWER[:DC]?

This command queries the input power of the power supply.

Command syntax : MEASure[:SCALar]:POWER?

Parameter : None

Return parameter : <NR2>

Return parameter unit : W

Example : MEAS:POW?

MEASure[:SCALar]:DVM[:DC]?

This command queries the voltage reading of the digital volt meter.

Command syntax : MEASure[:SCALar]:DVM?

Parameter : None

Return parameter : <NR2>

Return parameter unit : V

Example : MEAS:DVM?

SENSe:RESistance:RANGe

This command sets the range of the milliohm meter.

LOW: 0.01W resistance range

MIDDLE: 0.1W resistance range

HIGH: 1W resistance range

Command syntax : SENSe:RESistance:RANGe

Parameter : LOW | MIDdle | HIGH

Example : RES:RANG LOW

Query syntax : SENSe:RESistance:RANGe?

Return parameter : <SRD>

MEASure[:SCALar]:RESistance[:DC]?

This command queries the resistance reading of the milliohm meter.

Command syntax : MEASure[:SCALar]: RESistance?

Parameter : None

Return parameter : <NR2>

Return parameter unit : R

Example : MEAS:RES?

Interface Configuration Commands

[SOURCE:]SYSTEM:SENSE [:STATE]{<bool>}

This command enables/disables the power supply's remote sense function.

Command syntax : SYSTEM: SENSE [:STATE] <bool>

Parameter : 0|1|ON|OFF

Query syntax : SYSTEM:SENSE [:STATE] ?

*RST value : 0

[SOURCE:]PORT:FUNCTION

This command sets the mode of the port in the rear panel.

TRIGGER function: Pin1, pin2 are configured as external trigger source for the power supply and to control the list operation.

RI/DFI function : Inhibit Input controls the output state of the power supply. The Fault Output can indicate the reason for internal failure.ο

DIGITAL I/O function : Read and control the state of the digital port

Command syntax : SOURCE:PORT:FUNCTION

Parameter : TRIGger|RIDFi|DIGital

Query syntax : SOURCE:PORT:FUNCTION ?

*RST value : TRIGger

[SOURCE:]RI:MODE

This command sets the input mode of the RI input pin

Command syntax : SOURCE:RI:MODE

Parameter : OFF|LATChing|LIVE

Query syntax : SOURCE:RI:MODE ?

*RST value : OFF

[SOURCE:]DFI:SOURCE

This command sets output source of the DFI output pin.

Command syntax : SOURCE:DFI:SOURCE

Parameter : OFF|QUES|OPER|ESB|RQS

Query syntax : SOURCE:DFI:SOURCE ?

*RST value : OFF

[SOURCE:]DIGITAL:OUTPut[:STATE]

This command sets the output state of the digital port. This command can be used when the mode of the port is set to DIGITAL.

Command syntax : SOURCE:OUTPut[:STATE]

Parameter : OFF|ON|0|1

[SOURCE:]DIGital:INPut[:STATe]?

This command sets the input state of port. This command can be used when the mode of the port is set to DIGITAL.

Command syntax : SOURCE:DIG:INPut[:STATe] ?

Trigger commands

TRIGger[:IMMediate]

When trigger source is command mode, this command will give a trigger signal. Its function is as the same as *TRG command.

Order syntax : * TRIGger[:IMMediate]

Parameter : None

Reference order : TRIG TRIG:SORU

TRIGger:SOURce

This command sets the trigger mode of the power supply.

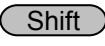
- IMMEDIATE:
When this function is enabled, you can generate an immediate trigger pulse by pressing  plus Trigger.
- EXTERNAL trigger signal (TTL):
When this function is enabled, the power supply can be triggered with a TTL pulse applied to pin 1 of the terminal connector in the rear. The TTL on pulse width should be at least 5 ms.
- BUS Command
When this function is enabled, you can trigger the power supply by sending a *TRG or TRIGGER command to the power supply

Command syntax : TRIGger:SOURce <mode>

Parameter : IMMEDIATE|EXTERNAL|BUS

*RST value: KEY

Calibration commands

CALibration:SECure:[STATe]

Set protection mode enable or disable when calibrating the power supply.

Command syntax : CALibration:SECure:[STATe]{ON|OFF>,[<password>]}

Parameter : 0|1|ON|OFF, '5811

Example : CAL:SEC 1, '5811; CAL:SEC OFF

Query syntax : CALibration:SECure:STATe ?

Parameter : None

CALibration:VOLTage:LEVel

This command sets the voltage calibration point.

Command syntax : CALibration:VOLTage:LEVel <point>

Parameter : P1|P2

CALibration:VOLTage [:DATA] {<numeric value>}

Returns the actual output voltage value of calibration point.

Command syntax : CALibration:VOLTage [:DATA] <NRf>

Parameter : <NRf>

Example : CAL:VOLT 30.0002V

CALibration:CURREnt:LEVel

This command sets the current calibration points. P1,P2,P3,P4.

Command syntax : **CALibration:CURREnt:LEVel <point>**

Parameter : P1|P2

CALibration:CURREnt [:DATA] {<numeric value>}

Return actual output current value to calibration point.

Command syntax : **CALibration:CURREnt [:DATA] <NRf>**

Parameter : <NRf>

Example : CAL:VOLT 3.0002A

CALibration:DVM:LEVel

This command can set current calibration point. P1,P2,P3,P4.

Command syntax : CALibration:DVM:LEVel <point>

Parameter : P1|P2|P3|P4

CALibration:DVM [:DATA] {<numeric value>}

Return actual output current value to calibration point.

Command syntax : CALibration:DVM [:DATA] <NRf>

Parameter : <NRf>

Example : CAL:VOLT 3.0002A

CALibration:SAVE

This command saves the calibration coefficient into nonvolatile register.

Command syntax : CALibration:SAVE

Parameter : None

CALibration: INITial

This command resets the current calibration coefficients to their default values.

Command syntax: CALibration: INITial

Parameter: None

5 Specifications

5.1 Specifications

Models 9120A, 9121A and 9124

Parameter		9120A	9121A	9124
Output Ratings (0 °C~40 °C)	Voltage	0 ~32V	0 ~20V	0~72V
	Current	0~3A	0~5A	0~1.2A
	LVP*	0 ~33V	0 ~21V	0 ~73V
Load Regulation ±(% of output+offset)	Voltage	<0.01%+2mV		<0.01%+2mV
	Current	<0.05%+1mA		<0.05%+0.3mA
Line Regulation ±(% of output+offset)	Voltage	<0.01%+1mV		<0.01%+1mV
	Current	<0.05%+0.1mA		≤0.05%+0.05mA
Programming resolution	Voltage	0.1mV		0.1mV
	Current	0.1mA		0.05mA
Readback/Meter resolution	Voltage	0.1mV	0.1mV	0.5mV
	Current	0.01mA	0.05mA	0.01mA
Front Panel setting resolution	Voltage	0.5mV		2mV
	Current	0.1mA		0.1mA
Programming accuracy, 12 months (25 °C ± 5 °C) ±(% of output+offset)	Voltage	<0.03%+3mV		≤0.03%+6mV
	Current	<0.05%+2mA		≤0.05%+1mA
Readback / Meter accuracy 12months (25 °C ± 5 °C) ±(% of output+offset)	Voltage	<0.02%+3mV		≤0.02%+5mV
	Current	<0.05%+2mA		≤0.05%+1mA
Ripple & Noise (20Hz ~20MHz)	Voltage	≤ 4mV _{p-p}	≤ 3mV _{p-p}	≤ 5mV _{p-p}
	Current	≤ 3mArms	≤ 3mArms	≤ 3mArms
Temperature coefficient, (0 °C~40 °C) ±(% of output+offset)	Voltage	<0.02%+3mV		≤0.02%+5mV
	Current	<0.05%+2mA		<0.05%+0.5mA
Readback temperature, coefficient, ±(% of output+offset)	Voltage	<0.02%+3mV		≤0.02%+5mV
	Current	<0.05%+2mA		≤0.05%+0.5mA
DVM Accuracy	Voltage	0~12V range: 0.02%+2mV 0~40V range: 0.02%+3mV		
DVM Resolution	Voltage	0~12V range: 0.1mV 0~40V range: 1mV		
Ohm meter	mΩ	Accuracy: 0.1%, for Voltage and Current ≥ 10% of FS (full scale) Accuracy: 0.3% for Voltage and Current ≥ 3% of FS		
Weight	net	19.8 lbs, (9 kg)		
Dimensions	WxHxD	214.5mm × 88.2mm × 354.6mm 8.45(W) x 3.47(H) x 13.9(D) inch		

*) LVP: Limit Voltage Protection. Limits the voltage than can be set either via the front panel or remote control command.

NOTE: Specifications and information are subject to change without notice. Please visit www.bkprecision.com for the most current product information.

Models 9122A, 9123A

Parameter		9122A	9123A
Output Ratings (0 °C~40 °C)	Voltage	0 ~60V	0 ~30V
	Current	0~2.5A	0~5A
	LVP*	0 ~61V	0 ~31V
Load Regulation ±(% of output+offset)	Voltage	<0.01%+2mV	
	Current	<0.05%+0.5mA	<0.05%+1.5mA
Line Regulation ±(% of output+offset)	Voltage	<0.01%+2mV	<0.01%+1mV
	Current	<0.05%+0.05mA	<0.05%+0.1mA
Programming resolution	Voltage	0.5mV	0.1mV
	Current	0.1mA	
Readback/Meter resolution	Voltage	0.5mV	0.1mV
	Current	0.05mA	
Front Panel setting resolution	Voltage	0.1mV	0.5mV
	Current	0.1mA	
Programming accuracy, 12 months (25 °C ± 5 °C) ±(% of output+offset)	Voltage	<0.03%+6mV	<0.03%+3mV
	Current	<0.05%+1.5mA	<0.05%+2.5mA
Readback / Meter accuracy 12months (25 °C ± 5 °C) ±(% of output+offset)	Voltage	<0.02%+6mV	<0.02%+2.5mV
	Current	<0.05%+1.5mA	<0.05%+2.5mA
Ripple & Noise (20Hz ~20MHz)	Voltage	≤ 5mV _{p-p}	≤ 4mV _{p-p}
	Current	≤ 3mA _{rms}	≤ 4mA _{rms}
Temperature coefficient, (0 °C~40 °C) ±(% of output+offset)	Voltage	<0.02%+6mV	<0.02%+3mV
	Current	<0.05%+1mA	<0.05%+2mA
Readback temperature, coefficient, ±(% of output+offset)	Voltage	<0.02%+6mV	<0.02%+3mV
	Current	<0.05%+1mA	<0.05%+2mA
DVM Accuracy	Voltage	0~12V range: 0.02%+2mV 0~40V range: 0.02%+3mV	
DVM Resolution	Voltage	0~12V range: 0.1mV 0~40V range: 1mV	
Ohm meter	mΩ	Accuracy: 0.1%, for Voltage and Current ≥ 10% of FS (full scale) Accuracy: 0.3% for Voltage and Current ≥ 3% of FS	
Weight	net	21.2 lbs, (9.6 kg)	
Dimensions	WxHxD	214.5mm × 88.2mm × 354.6mm 8.45(W) x 3.47(H) x 13.9(D) inch	

*) LVP: Limit Voltage Protection. Limits the voltage than can be set either via the front panel or remote control command.

NOTE: Specifications and information are subject to change without notice. Please visit www.bkprecision.com for the most current product information.

5.2 Supplemental Characteristics

State Storage Memory

50 user-configurable stored states

Recommended Calibration Interval

1 year

AC Input Ratings (selectable via switch on the rear panel)

220AV±10% , 47 ~ 63Hz

110AV±10% , 47 ~ 63Hz

Maximum output power

9120A	9121A	9124	9122A	9123A
96W	100W	86W	150W	150W

Cooling

Fan cooled

Operating Temperature

0 to 40 °C

Storage Temperature

-20 to 70 °C.

Environmental Conditions

Designed for indoor use in an installation category II, pollution degree 2 environments. Designed to operate at maximum relative humidity of 95% and at altitudes of up to 2000 meters.

Dimensions:

214.5mm (W) x 88.2 mm (H) x 354.6mm (D)

all units in mm

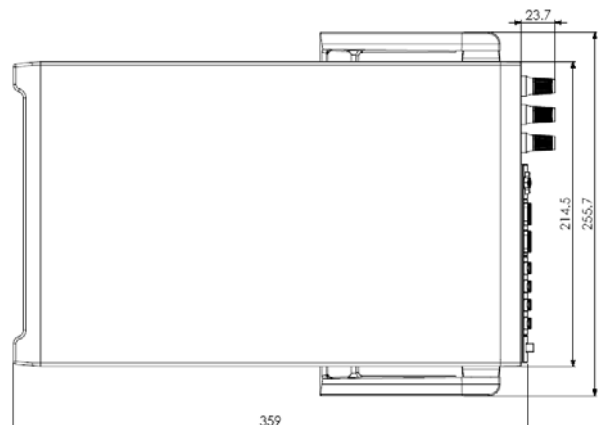
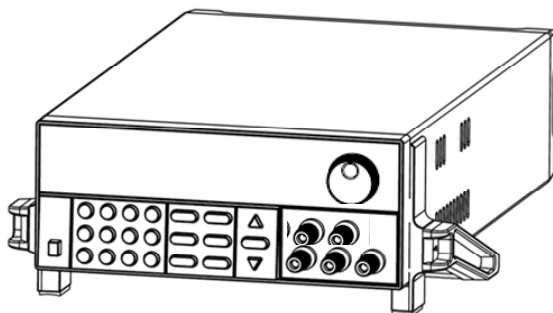
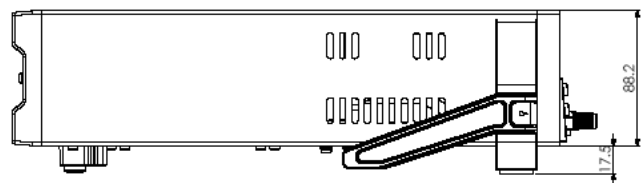
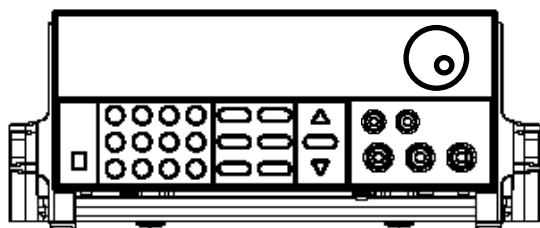

Service Information

Warranty Service: Please return the product in the original packaging with proof of purchase to the address below. Clearly state in writing the performance problem and return any leads, probes, connectors and accessories that you are using with the device.

Non-Warranty Service: Return the product in the original packaging to the address below. Clearly state in writing the performance problem and return any leads, probes, connectors and accessories that you are using with the device. Customers not on open account must include payment in the form of a money order or credit card. For the most current repair charges please visit www.bkprecision.com and click on “service/repair”.

Return all merchandise to B&K Precision Corp. with pre-paid shipping. The flat-rate repair charge for Non-Warranty Service does not include return shipping. Return shipping to locations in North America is included for Warranty Service. For overnight shipments and non-North American shipping fees please contact B&K Precision Corp.

B&K Precision Corp.
22820 Savi Ranch Parkway
Yorba Linda, CA 92887
www.bkprecision.com
714-921-9095

Include with the returned instrument your complete return shipping address, contact name, phone number and description of problem.

Limited One-Year Warranty

B&K Precision Corp. warrants to the original purchaser that its products and the component parts thereof, will be free from defects in workmanship and materials for a period of one year from date of purchase.

B&K Precision Corp. will, without charge, repair or replace, at its option, defective product or component parts. Returned product must be accompanied by proof of the purchase date in the form of a sales receipt.

To obtain warranty coverage in the U.S.A., this product must be registered by completing a warranty registration form on www.bkprecision.com within fifteen (15) days of purchase.

Exclusions: This warranty does not apply in the event of misuse or abuse of the product or as a result of unauthorized alterations or repairs. The warranty is void if the serial number is altered, defaced or removed.

B&K Precision Corp. shall not be liable for any consequential damages, including without limitation damages resulting from loss of use. Some states do not allow limitations of incidental or consequential damages. So the above limitation or exclusion may not apply to you.

This warranty gives you specific rights and you may have other rights, which vary from state-to-state.

B&K Precision Corp.
22820 Savi Ranch Parkway
Yorba Linda, CA 92887
www.bkprecision.com
714-921-9095



22820 Savi Ranch Parkway
Yorba Linda, CA 92887
www.bkprecision.com

© 2007 B&K Precision Corp.