



Instruction Manual

Version: February 5, 2009

Model 1785B, 1786B, 1787B & 1788 Programmable DC Power Supplies

Content

Content.....	2
Quick Reference.....	3
About your safety.....	3
General information.....	3
Protection from electric shock	3
Definition of users.....	3
Certification and Warranty.....	4
Certification.....	4
Introduction.....	4
The Front Panel at a Glance.....	5
Function keys description.....	5
Menu description	6
Display annunciators.....	6
The Rear Panel at a Glance	7
Chapter 1 Quick Start	8
1.1 Preliminary Checkout.....	8
ERR EEPROM.....	8
ERROR CAL	8
1.2 Output Checkout.....	9
1.2.1 Voltage Output Checkout	9
1.2.2 Current Output Checkout	9
1.3 If the Power Supply Does Not Turn On	10
1.4 To Adjust the Carrying Handle	10
1.5 To Rack Mount the Instrument.....	11
Chapter 2 Specifications.....	12
2.1 Specifications	12
2.2 Supplemental Characteristics	13
Chapter 3 Front-panel Operation.....	15
3.1 Front-panel Operation Overview	15
3.2 Constant Voltage Operation	15
3.3 Constant Current Operation	16
3.4 Saving and Recalling Operation.....	16
3.5 Menu Operation	16
Chapter 4 Remote Operation Mode	19
4.1 IT-E131 Communication cable.....	19
4.2 Communication setting	19
4.3 Frame format.....	20
<i>Packet structure</i>	20
<i>Status packets</i>	21
4.4 Communication protocol.....	23
Chapter 5 PV1785B-1788 Software	29
5.1 Introduction	29
5.2 System Installation.....	29
5.3 Functions of PV-1785B-1788.....	29
5.3.1 Configure the system	31
5.3.2 Status bar.....	31
5.3.3 Setting Voltage and current.....	32
5.3.4. GO/NG Test Function.....	34
5.3.5 Save and Open.....	34
5.3.6 Present Voltage/Current Chart	34
5.3.7 Chart Description.....	35

Quick Reference

About your safety

Please review the following safety precautions before operating our equipment.

General information

The following safety precautions should be observed before using this product and any associated instrumentations. Although some instruments and accessories would be used with non-hazardous voltages, there are situations where hazardous conditions may be present.

This product is intended for use by qualified personnel who recognize shock hazards and are familiar with the safety precautions required to avoid possible injury. Read and follow all installation, operation, and maintenance information carefully before using the product. Refer to this manual for complete product specifications.

If the product is used in a manner not specified, the protection provided by the product may be impaired.

Before performing any maintenance, disconnect the line cord and all test cables.

Protection from electric shock

Operators of this instrument must be protected from electric shock at all times. The responsible body must ensure that operators are prevented access and/or insulated from every connection point. In some cases, connections must be exposed to potential human contact. Product operators in these circumstances must be trained to protect themselves from the risk of electric shock. If the circuit is capable of operating at or above 1000 volts, no conductive part of the circuit may be exposed.

Definition of users

Responsible body is the individual or group responsible for the use and maintenance of equipment is operated within its specifications and operating limits, and for ensuring that operators are adequately trained.

Operators use the product for its intended function. They must be trained in electrical safety procedures and proper use of the instrument. They must be protected from electric shock and contact with hazardous live circuits.

Service is only to be performed by qualified service personnel.

Safety symbols and terms



Connect it to safety earth ground using the wire recommended in the user manual.



The symbol on an instrument indicates that the user should refer to the operating instructions located in the manual.



High voltage danger

Certification and Warranty

Certification

We certify that this product met its published specifications at time of shipment from the factory.

Introduction

The 1785B - 1788 Series power supplies are high performance single-output programmable DC power supplies with communication interface. The combination of bench-top and system features in these power supplies provides versatile solutions for your design and test requirements.

Convenient bench-top features:

- Nice appearance, small-size and light weight
- VFD display
- Soft Rubber numeric keypad
- Adjustable & constant voltage outputs
- Adjustable & constant current outputs
- Output on/off
- High accuracy and high resolution
- Excellent load and line regulation
- Low ripple and noise
- Limit voltage protection
- Over current/temperature protection
- Sixteen operating states storage
- May be used in series or parallel modes with additional power supplies

The Front Panel at a Glance

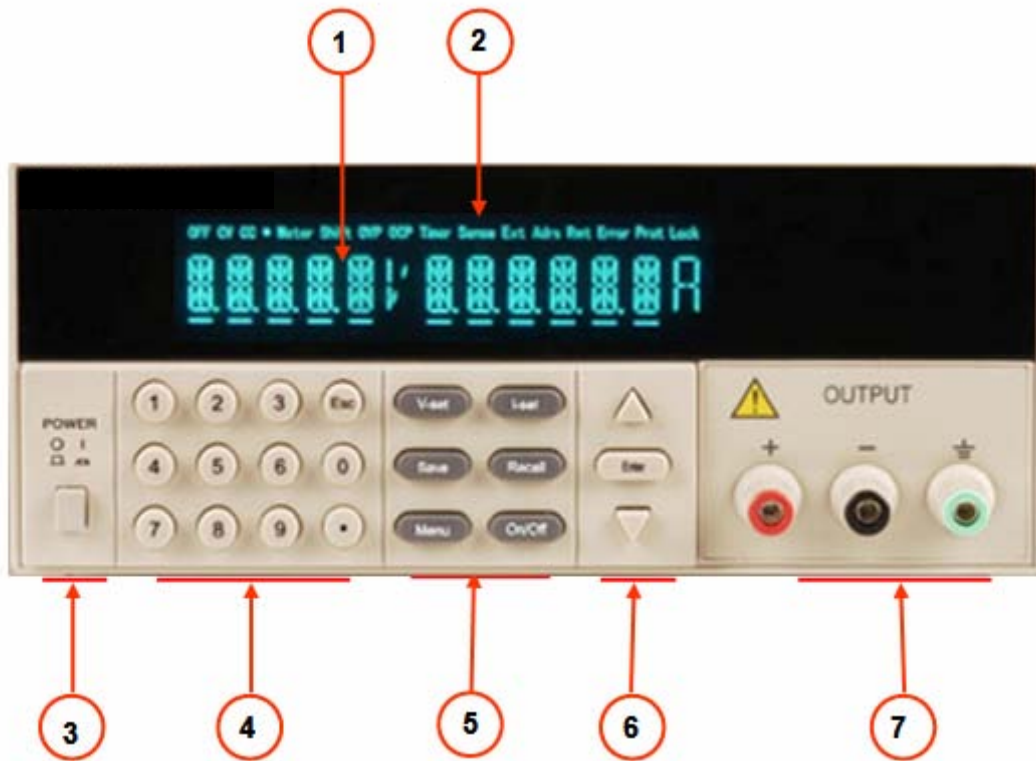

- ① 10 digits VFD display
- ② Status information for operating mode and working status
- ③ Power switch
- ④ Number keys
- ⑤ Function keys
- ⑥ UP/DOWN and ENTER key
- ⑦ Output terminals

Function keys description

V-set	Set the output voltage value
I-set	Set the current value
Save	Save the present settings to a specified register location(1~16)
Recall	Recall a saved settings from location "1"through "16"
Menu	Menu function to set related parameters of the power supply
Out on/off	Output ON/OFF, to enable/disable the output

Menu description

Menu		
▼	> MAX VOLT	Set the maximum output voltage value
▼	> INIT OUT	Initiate the output state to ON or not
▼	> INIT VOL	Initiate the output voltage to 0 volt or not
▼	> KEY SOUN	Switch On/Off the buzzer sound when you press any key
▼	> BAUD RATE	Set the communication baud rate
▼	> ADDR	Set the communication address
▼	> KEY LOCK	Set the password for function keys
▼	> EXIT	Exit

Display annunciators

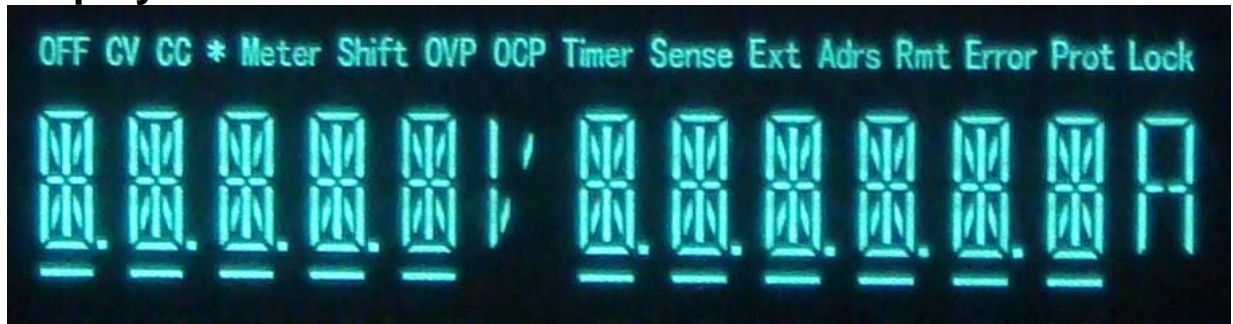

OFF	The power supply's output is off	Timer	Not used
CV	Constant voltage mode	Sense	Not used
CC	Constant current mode	Ext	Not used
*	Not used	Adrs	The instrument is communicating with an IT-E131/IT-E132/IT-E133
Meter	Meter mode	Rmt	The instrument is in remote state. The only active key is the Local KEY.
Shift	Not used	Error	The instrument has error
OVP	Over voltage protect state	Prot	Not used
OCP	Over current protect state	Lock	The keyboard is locked by a password

The Rear Panel at a Glance

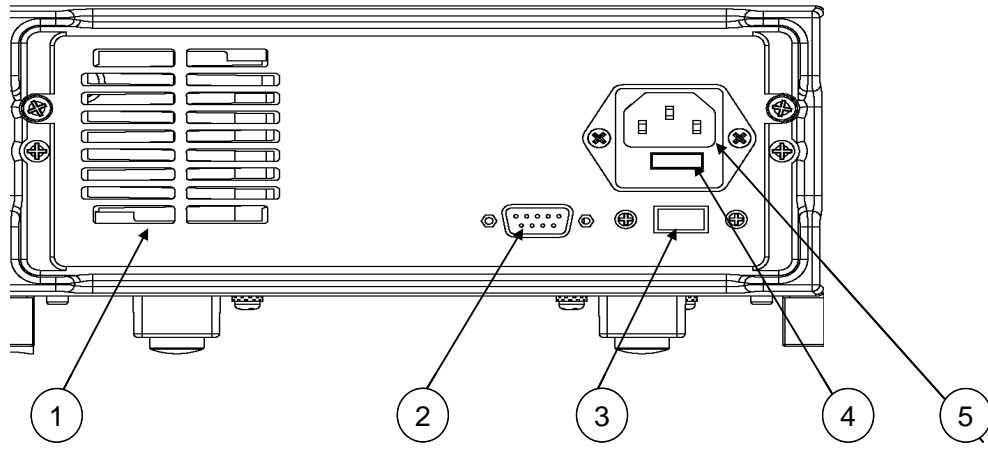

- ① Cooling window
- ② DB9 interface connector
- ③ 110V/220V selector
- ④ Fuse
- ⑤ Power socket

Chapter 1 Quick Start

One of the first things you will want to do with your power supply is to become acquainted with the front panel. The exercises in this chapter prepare the power supply for use and help you get familiar with some of its front-panel operations.

This chapter is intended for both the experienced and the inexperienced user because it calls attention to certain checks that should be made prior to operation.

1.1 Preliminary Checkout

The following steps help you verify that the power supply is ready for use.

1 . Check the list of supplied items.

Verify that you have received the following items with your power supply. If anything is missing, contact your nearest Sales Office.

- One power cord for your location
- This User's Manual.
- Communication cable (optional)

2 . Connect the power cord and turn on the power supply.

When you turn on the power supply, the front-panel display will light up briefly while the power supply performs its power-on self-test. All the VFD annunciators will light up at once. To review the display with all annunciators, you can check if there is any stroke loss on any annunciator. If there isn't any response when you power on the power supply, please see Section 1.5 on page 10 for some service information.

If the EEPROM was damaged or the latest operation data in EEPROM was lost, the VFD will display as follows:

ERR EEPROM

If the calibration data in EEPROM was lost, the VFD will display as follows:

ERROR CAL



Warning: Your power supply is equipped with a 3-wire grounding type power cord; the third conductor being the ground. The power supply is grounded only when the power-line cord is plugged into an appropriate receptacle. Do not operate your power supply without adequate cabinet ground connection.

1.2 Output Checkout

The following procedures check to ensure that the power supply develops its rated outputs and properly responds to operation from the front panel.

1.2.1 Voltage Output Checkout

The following steps verify basic voltage functions without load.

1. Turn on the power supply.

2. Enable the outputs.

Press **Out on/off** key to let the ON annunciator and the CV annunciator turn on to light.

Notice: if the voltage value flash, then the power supply is in *Set* mode, "Set mode" means that the VFD display shows the setting output voltage and current. Or the power supply is in *Meter* mode, "Meter mode" means that the VFD display shows the actual output voltage and current and the "Meter" annunciator is lit.

3. Check that the front-panel voltmeter properly responds to number keys

Set some different voltage values, then wait till the Meter mode to check if the VFD displayed voltage value is the same as the set voltage value, and to check if the VFD displayed current value is nearly zero.

4. Ensure that the voltage can be adjusted from zero to the full rated value.

1.2.2 Current Output Checkout

The following steps check basic current functions with a short across the power supply's output.

1. Turn on the power supply.

2. Disable the output

Press **Out on/off** key to ensure that the output is disabled. The OFF annunciator is turned on.

3. Connect a short across (+) and (-) output terminals with an insulated test lead.

Use a wire size sufficient to handle the maximum current.



Warning : To satisfy safety requirements, load wires must be heavy enough not to overheat when carrying the maximum short-circuit output current of the power supply. If there is more than one load, then any pair of load wires must be capable of safely carrying the full-rated current of the power supply.

4. Enable the output.

Press **Out on/off** key to ensure that the output is enabled. The OFF annunciator is turned off.

5. Adjust the voltage value to 1.0 volt.

Adjust the voltage to 1.0 volt to ensure the power supply is in CC operation mode. The CC annunciator will turn on.

6. Adjust the current value.

Set some different voltage values, then wait till the Meter mode to check if the VFD displayed current value is the same as the set voltage value, and to check if the VFD displayed voltage value is nearly zero.

7. Ensure that the current can be adjusted from zero to the full rated value.

8. Turn off the power supply and remove the short wire from the output terminals.

1.3 If the Power Supply Does Not Turn On

Use the following steps to help solve problems you might encounter when turning on the instrument. If you need more help, refer to chapter 6 for instructions on returning the instrument to the supplier for service.

1. Verify that there is AC power to the power supply.

First, verify that the power cord is firmly plugged into the power receptacle on the rear panel of the power supply. You should also make sure that the power source you plugged the power supply into is energized. Then, verify that the power supply is turned on.

2. Verify the power-line voltage setting.

The line voltage is set to the proper value for your country (110VAC or 220VAC). Change the voltage setting if it's not correct.

3. Verify that the correct power-line fuse is installed.

If the fuse was damaged, please see the table below to replace the fuse for your power supply.

	Fuse Description
	Fuse 2.5A T 250V for 220VAC
	Fuse 5A T 250V for 110VAC

1.4 To Adjust the Carrying Handle

To adjust the position, grasp the handle by the sides and pull outward. Then, rotate the handle to the desired position.

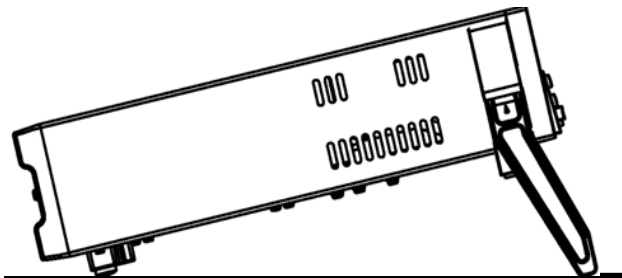
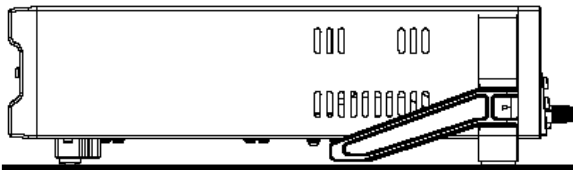

Bench-top viewing positions

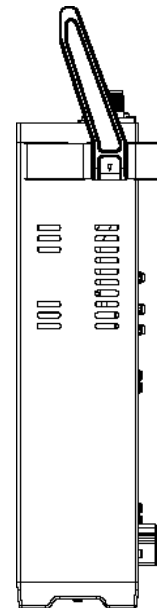

Carrying position

1.5 To Rack Mount the Instrument

You can mount the power supply in a standard 19-inch rack cabinet using the IT-E151 rack mount kit.

Note: Remove the carrying handle and the two plastic ears before rack-mounting the instrument. To remove the handle, grasp the handle by sides and pull outwards and rotate it to a special position to let the arrow on the handle and the arrow on the plastic ears be in opposite directions, then pull the handle outward. After removing the handle, you can use a screwdriver to remove the two plastic ears.

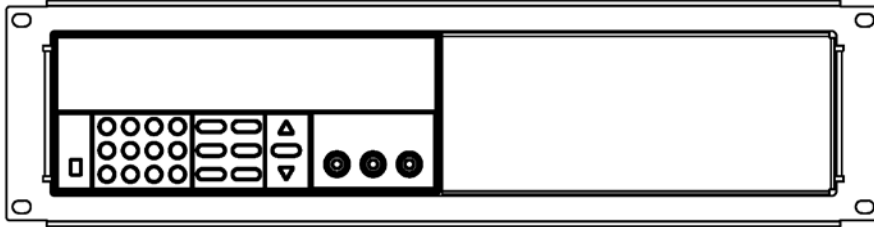

To rack mount a single instrument, order rack mount kit IT-E151

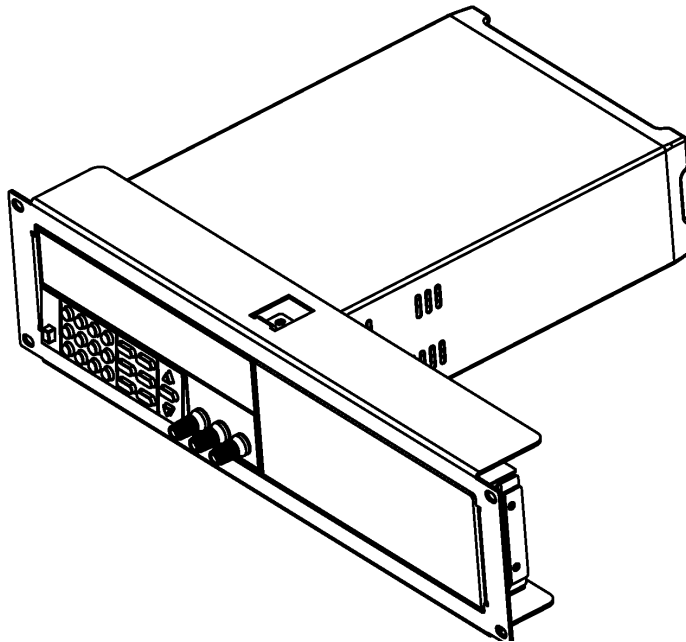

Side view of rack mounting a single instrument

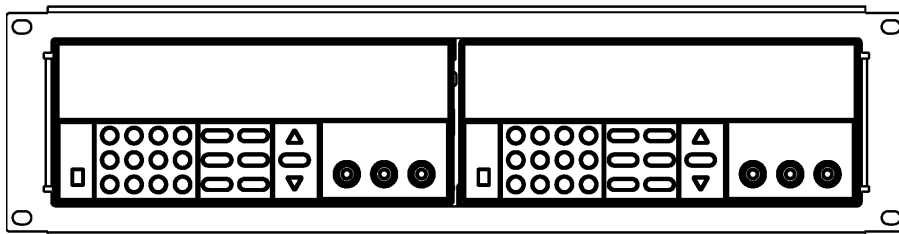

To rack mount two instruments side-by-side, order rack mount kit IT-E151, you needn't to use the front cover panel.

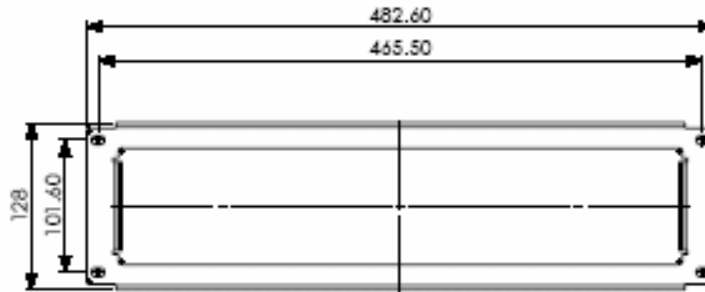
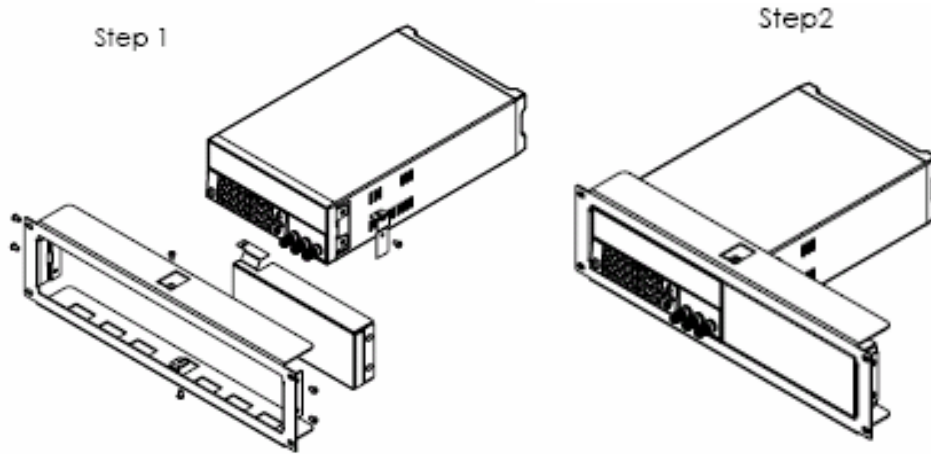

Dimension

unit (mm)

Chapter 2 Specifications

2.1 Specifications

Parameter		1785B	1786B	1787B	1788
Output Ratings, (0 °C - 40 °C)	Voltage	0 ~18 V	0 ~32 V	0 ~72 V	0 ~32 V
	Current	0 ~5 A	0 ~3 A	0~1.5 V	0~6 A
	LVP	0 ~19 V	0 ~33 V	0 ~73 V	0 ~33 V
Load Regulation, ±(% of output+offset)	Voltage	(rated current ≤ 3 A) ≤0.01% + 3 mV (rated current ≤ 10 A) ≤0.02% + 5 mV			
	Current	≤0.01% + 3 mA			
Line Regulation, ±(% of output+offset)	Voltage	≤0.01% + 3 mV			
	Current	≤0.1% + 2 mA			
Programming Resolution	Voltage	10 mV			
	Current	10 mA			
Readback Resolution	Voltage	10 mV(<20 V)			
		100 mV(≥20 V)			

	Current	10 mA
Programming Accuracy, 12months, (@ 25 °C ± 5 °C) ±(% of output+offset)	Voltage	≤0.05% + 10 mV
	Current	<0.2%+10 mA
Readback Accuracy 12months, (25 °C ± 5 °C) ±(% of output+offset)	Voltage	<0.05%+15 mV(<20 V), <0.05%+120 mV(≥20 V)
	Current	<0.1%+15 mA
Ripple (20Hz ~20MHz)	Voltage	≤0.5 mVrms/3 mVp-p
	Current	5 mArms
Temperature Coefficient, (0 °C ~ 40 °C) ±(% of output+offset)	Voltage	<0.02%+5 mV
	Current	<0.1%+5 mA
Readback Temperature, Coefficient, ±(% of output+offset)	Voltage	<0.02%+15 mV(<20 V), <0.02%+120 mV(≥20 V)
	Current	<0.1%+15 mA

2.2 Supplemental Characteristics

State Storage Memory

Sixteen (16) user-configurable stored states

Recommended Calibration Interval

1 year

AC Input Ratings (selectable via switch on the rear panel)

Option OP1: 220VAC ± 10%, 47 to 63 Hz

Option OP2: 110 VAC ± 10%, 47 to 63 Hz

Maximum input power

350VA

Cooling

Fan cooled

Operating Temperature

32 to 104 °F (0 to 40 °C) for full rated output

Storage Temperature

-68 to 158 °F (-20 to 70 °C) for storage environment.

Environmental Conditions

Designed for indoor use in an installation category II, pollution degree 2 environment. Designed to operate at maximum relative humidity of 95% and at altitudes of up to 2000 meters.

Weight

Type	1785B	1786B	1787B	1788
N.W	12.3Lbs. 5.6Kg	14.8Lbs. 6.7Kg	14.8Lbs. 6.7Kg	14.8Lbs. 6.7Kg
G.W	14Lbs. 6.4Kg	16.5Lbs. 7.5Kg	16.5Lbs. 7.5Kg	16.5Lbs. 7.5Kg

Dimensions WxHxD*

10" x 4.16" x 15" (255.7mm x 105.7mm x 382.7mm)

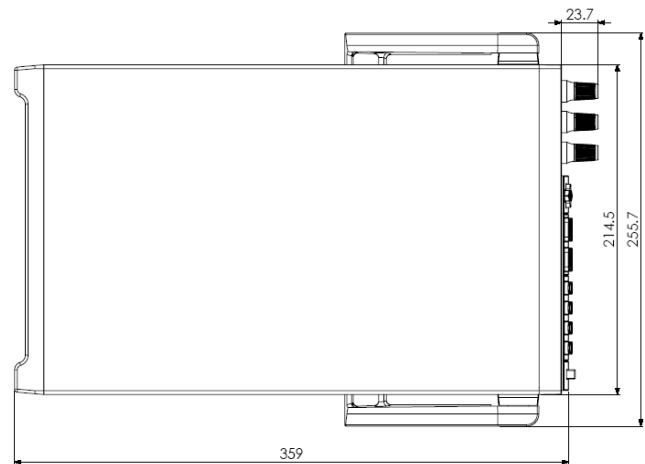
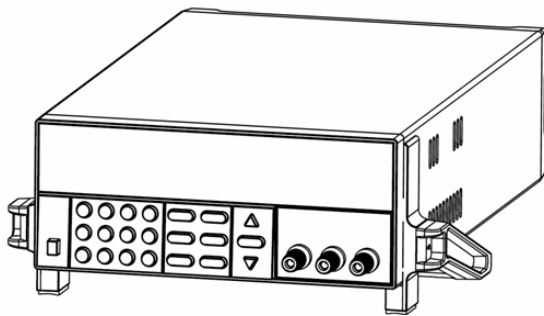
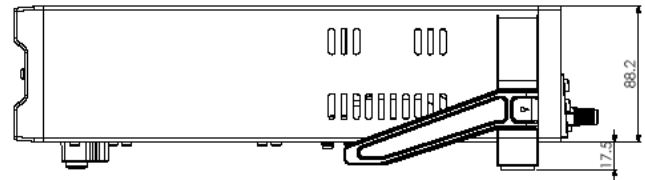
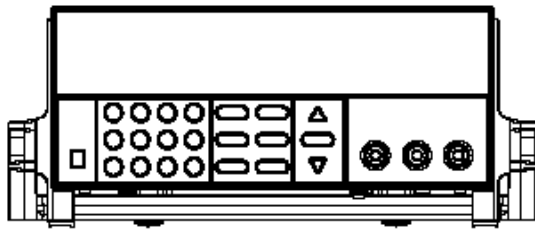

(Unit: mm)

Chapter 3 Front-panel Operation

So far you have learned how to install your power supply and do quick start. During the quick start, you were briefly introduced to operating from the front panel as you learned how to check basic voltage and current functions. This chapter describes in detail the use of the front-panel keys and shows how they are used to accomplish power supply operation.

This chapter is divided into the following sections:

- Front-Panel Operation Overview, on page 14
- Constant Voltage Operation, on page 15
- Constant Current Operation, on page 15
- Storing and Recalling Operating States, on page 15
- MENU operation, starting on page 16

3.1 Front-panel Operation Overview

The following section describes an overview of the front-panel keys before operating your power supply.

1. The power supply is shipped from the factory configured in the front-panel operation mode. At power-on, the power supply is automatically set to operate in the front-panel operation mode. When in this mode, the front panel keys can be used.
2. When the power supply is in remote operation mode, you cannot use the front-panel. A change between front-panel and remote operation modes will not result in any change in the output parameters. You can change the front-panel and remote operation modes by computer.
3. The power supply is in *Meter* mode when it is powered on, and the VFD will display the actual voltage and current output value. And in this mode, if any non-functional key is pressed, the power supply will be changed to *Set* mode, and the VFD will display the adjusted voltage and current value. In *Set* mode, the set voltage value will flash, you can press ▲ and ▼ keys to adjust the voltage value. In *Set* mode, the power supply will turn back to *Meter* mode if there is no any key is pressed for 3 seconds.
4. The output of the power supply can be enabled or disabled from the front panel by pressing  key. When the output is on, the ON annunciator will turn off.
5. The VFD display shows the present operating status of the power supply with annunciators. For example, the power supply is operating in CV mode, and then the CV annunciator will turn on. If, the power supply is remotely controlled, the Rmt annunciator will also turn on, See “Display Annunciators”.

3.2 Constant Voltage Operation

The constant voltage range is from 0V to the maximum voltage value of each model. It is very easy for you to set the constant voltage output. You have 2 solutions to set the constant voltage value.

Solution 1:

Step1. Power on the Power Supply

Step2. Press the ▲ and ▼ keys to change the value

Solution 2:

Step1. Power on the instrument

Step2. Press **V-Set** key.

Step3. Use the numeric keys **0** to **9** or **▲** and **▼** keys to change the voltage value.

Step4. Press **Enter** to confirm the value

3.3 Constant Current Operation

The constant current output range is from 0A to the maximum current value of each type. It is very easy for you to set the constant current output.

Step1. Power on the Power Supply

Step2. Press **I-Set** key

Step3. Use the numeric keys **0** to **9** or use **▲** and **▼** keys to change the current value

Step4. Press **Enter** key to confirm the value

3.4 Saving and Recalling Operation

You can store up to 16 different output states in storage register locations (1 to 16). Each output state includes Constant voltage value, Constant current value and Maximum output voltage value. When shipped from factory, storage locations "1" through "16" are empty. You can recall the saved settings by Recall function.

Step1. After you setting an output state (CV value, CC value and Maximum voltage), press **Save** key.

Step2. Use the numeric keys **0** to **9** or **▲** and **▼** keys to select the memory location (the range is 1 to 16) which you want to store in.

Step3. Press **Enter** to confirm the memory location.

Step4. Press **Recall** key.

Step5. Use numeric keys **0** to **9** or **▲** and **▼** keys to select the states which you want to recall.

Step6. Press **Enter** key to confirm. Then the saved settings will come on.

Note: 1. If the function keys were locked by password, you need to enter the correct password after you press function keys (V-set, I-set, Save, Recall and Menu), then you can do the settings.

2. If you want to cancel a function operation (V-set, I-set, Save, Recall or Menu), just press **Esc** key to exit.

■ Set Maximum voltage(>MAX VOLT)

Please be well known that the Max voltage value should be in the range of each type of Power supply.

Menu

Step1. Press key.

Step2. Select >MAX VOLT by using ▲ and ▼ key.

Step3. Press key.

Step4. Change the voltage value by using numeric keys to or ▲ and ▼ key.

Step5. Press key.

Note: After you setting the maximum voltage value, the output voltage setup should be in the range from 0 volt to maximum voltage. The default maximum voltage is the full voltage range of its model.

■ Initiating the Output state(>INIT OUT)

This instruction can initiate the output state when the power supply is powered on. If you select ON, the power supply will initiate the output to OFF state when the power supply is powered on. If you select OFF, the output will remain the same state as last time you turned off the power supply

Note: Default selection is ON and the output state is always OFF state.

■ Initiating the Output Voltage (>INIT VOLT)

This instruction can set the initial output voltage. If you select ON, the power supply will initiate the output voltage to 0Volt when the power supply is powered on. If you select OFF, the output voltage will remain as the same volts as the last time you turned off the power supply

Note: Default setting is ON and the output voltage is 0 volt.

■ Setting the Key Sound(>KEY SOUND)

This instruction can switch on/off the buzzing sound when you press any key, If you select ON, the buzzer will sound when any key was pressed. If you select OFF, the buzzer will not sound when the keys were pressed.

Note: Default setting is ON; the buzzer will sound when you press any key.

■ Setting the Baud Rate(>BAUDRATE)

This instruction can change the communication baud rate for the power supply, the baud rate range is 4800 , 9600 , 19200 or 38400。 Before the communication, you must make sure that there is same baud rate between the power supply and the computer.

Note: Default baud rate is 4800.

■ **Setting Address (>ADDRESS)**

This instruction can set the communication address for each power supply. The address range is from 0 to 30. Before the communication, you must make sure that there is same address between the power supply and the computer.

Note: Default address is 0. When the power supply receives a frame instruction from computer, the LINK indicator will light on; it means that the power supply started to communicate with computer. If the power supply hasn't received the signal from computer for 3 seconds, the LINK indicator will be turned off and it means that the power supply can not communicate with computer.

■ **Setting password for function keys(>KEY LOCK)**

This instruction can set a password (1 through 4 digits) to lock the function keys operation. After setting the password, all the function keys on the front panel will be locked except the **OUT on/off** key. You must enter the correct password to unlock them, then you can continue to do the function key operation. If you don't want to lock the function keys, please don't press any number key when you enter the >KEY LOCK instruction, just press **ENTER** key to unlock it.

Note: When shipped from factory, there is no password and function keys are unlocked. The start bit of your desired password shouldn't be 0.

4.3 Frame format

Packet structure

The power supply is programmed using packets of bytes. A packet always contains 26 bytes, either going to or coming from the instrument. The basic programming rule is:

You send a **26 byte** packet to the instrument. You then read a **26 byte** packet back from the power supply to either

- Get the status of your submitted packet, or
- Get the data you requested.

The following are conventions we will follow in this chapter:

- 1.Hexadecimal integers will be represented by the prefix 0x.
- 2.Numbers are in base 10 number system unless otherwise indicated.
- 3.Byte numbering is zero-based, meaning numbering starts with 0.

The structure of each 26 byte packet is:

Byte 0	Byte 1	Byte 2	Byte 3 to 24	Byte 25
0xAA	Address	Command	Command's data	Checksum

Thus, the first byte of any command packet or returned packet is always 0xAA.

Address must be a byte that is between 0x00 and 0xFE. Setting of the address is optional. It is not required to communicate with the instrument. The address can be set from the front panel and is stored in non-volatile memory. This feature is useful when communicating via USB, and connecting several instruments, e.g. via a USB hub. In this scenario, Windows assigns a virtual COM port to each device which is unknown prior to establishing communications with the instrument (could be different each time). In this case, the user can correlate each virtual COM port randomly assigned by Windows with a user defined address.

Command is a byte that identifies which power supply command is used.

The area for the command's data contains parameter information for the command or the data that is requested via a previous command. Some commands have no data at all. It is a good programming practice to set all unused bytes to 0x00.

The checksum number is the arithmetic sum of each of the bytes modulo 256.

Status packets

When you send a command that does not cause the power supply to send requested information back to you, you will receive a status packet back. The structure of a status packet is

Byte 0	Byte 1	Byte 2	Byte 3	Byte 4 to 24	Byte 25
0xAA	Address	0x12	Status byte	Reserved	Checksum

The meaning of the return status byte is defined below:

0x90	Checksum incorrect
0xA0	Parameter incorrect
0xB0	Unrecognized command
0xC0	Invalid command
0x80	Command was successful

Description:

- 1 . Start bit is 0xAA, occupies a byte.
- 2 . Address range is 0x00 to 0xFE , occupies a byte.
- 3 . Command occupies a byte.
 - a . 0x20----Setting the remote control mode
 - b . 0x21----Setting the output ON/OFF state
 - c . 0x22----Setting the maximum output voltage
 - d . 0x23----Setting the output voltage
 - e . 0x24----Setting the output current
 - f . 0x25----Setting the communication address
 - g . 0x26----Reading the present current/voltage, maximum voltage, setup voltage/current and operation states of the power supply.
 - h . 0x27----Enter the calibration mode
 - i . 0x28----Reading the calibration mode state
 - j . 0x29----Calibrate voltage value.
 - k . 0x2A----Sending the actual output voltage to calibration program.
 - l . 0x2B----Calibrate current value.
 - m . 0x2C----Sending the actual output current to calibration program.
 - n . 0x2D----Save the calibration data to EEPROM.
 - o . 0x2E----Setting calibration information.
 - p . 0x2F----Reading calibration information.
 - q . 0x31----Reading product's model, series number and version information.

- r . 0x32----Restoring the factory default calibration data.
- s . 0x37----Enable the local key.
- t . 0x12----The return information of command operation in power supply.

Note: You must change the power supply to remote control mode first, then you can control the power supply output by computer. The command for remote control is 0x20. If you want to calibrate the power supply, set the calibration information. If you want to set the product serial number, you must set the calibration protection mode to OFF state first. The command for calibration protection is 0x27. When the power supply is in calibration mode, changes for the output state of power supply are not allowed.

- 4. 4th to 25th bytes are information content
- 5. 26th byte is check sum, the sum of the former 25 bytes.

Command Details:

In the following sections, we abbreviate the details of the commands. Since the first three bytes of a command are i) the constant 0xAA, ii) the instrument address, and iii) the command, we will not show those for each command. In addition, the 26th byte, the checksum, will also not be shown.

The table includes a column for **Byte offset**. This is the zero-based index of the byte in the packet. Note the offset numbers are in decimal.

A table entry of “Reserved” means the data are currently unused or reserved for future use. Good programming practice is to set these bytes to 0x00.

Some commands require two byte and four byte integers to represent parameter settings. These integers are stored in the command packet in **little-endian** format. Little-endian is a byte ordering format in which bytes with lower addresses have lower significance. We will refer to the individual bytes as follows:

For a two byte integer, the least significant byte will be called the low byte and the most significant byte will be called the high byte.

For a four byte integer, we will use the following notation:

- Least significant two bytes, least significant byte
- Least significant two bytes, most significant byte
- Most significant two bytes, least significant byte
- Most significant two bytes, most significant byte

As an example, for the integer 0x23A749F5, we'd have

1st byte: 0xF5 Lower low byte

2nd byte: 0x49 Lower high byte

3rd byte: 0xA7 Higher low byte

4th byte: 0x23 Higher high byte

4.4 Communication protocol

1 . Setting the remote control mode (0x20)

1 st byte	Start bit(0xAA)
2 nd byte	Address(0x00~0xFE)
3 rd byte	Command (0x20)
4 th byte	Operation mode(0 represent front panel operation mode, 1 represent remote operation mode)
5 th to 25 th byte	System reserve
26 th byte	Check sum

Note: You can not control the power supply from the front panel when the power supply is in calibration mode.

2 . Setting the output state ON/OFF (0x21)

1 st byte	Start bit (0xAA)
2 nd byte	Address(0x00~0xFE)
3 rd byte	Command (0x21)
4 th byte	Output state(0 is OFF , 1 is ON)
5 th to 25 th byte	System reserve
26 th byte	Check sum

3 . Setting the maximum output voltage (0x22)

1 st byte	Start bit (0xAA)
2 nd byte	Address(0x00~0xFE)
3 rd byte	Command (0x21)
4 th byte	The lowest byte of voltage upper limit (1 represents 1 mV)
5 th byte	The lower byte of voltage upper limit
6 th byte	The higher byte of voltage upper limit
7 th byte	The highest byte of voltage upper limit

8 th to 25 th byte	System reserve
26 th byte	Check sum

Note: Suppose you want to set the maximum voltage to 16.23 V. Since 1 represents 1mV, therefore 16.23 V translates to 16,230 in decimal. With 4 bytes in Hex, that would be 0x0003F6A. Since the bytes are ordered in little-endian format, 0x6A would be the 3rd byte, 0x3F the 4th byte, 0x00 as 5th byte, and 0x00 as the 6th byte.

4. Setting the output voltage (0x23)

1 st byte	Start bit (0xAA)
2 nd byte	Address(0x00~0xFE)
3 rd byte	Command (0x23)
4 th byte	The byte 0 of output voltage value
5 th byte	The byte 1 of output voltage value
6 th byte	The higher byte of output voltage value
7 th byte	The highest byte of output voltage value
8 th to 25 th byte	System reserve
26 th byte	Check sum

5 . Setting the output current (0x24)

1 st byte	Start bit (0xAA)
2 nd byte	Address (0x00~0xFE)
3 rd byte	Command (0x24)
4 th byte	To set the low byte of current value (1 represents 1 mA)
5 th byte	To set the high byte of current value
6 th to 25 th byte	System reserve
26 th byte	Check sum

Note: Suppose you want to set the maximum current to 3.12 A. Since 1 represents 1 mA, 3.12 A translates to 3,120 in decimal. With 2 bytes in Hex, that would be 0x0C30. Since the bytes are ordered in little-endian format, 0x30 would be the 4th byte, and 0x0C as 5th byte.

6. Setting the communication address (0x25)

1 st byte	Start bit (0xAA)
2 nd byte	The current address of power supply(0x00~0xFE)
3 rd byte	Command(0x25)
4 th byte	The new address
5 th to 25 th byte	System reserve
26 th byte	Check sum

7. Reading the present current/voltage, maximum voltage, setup voltage/current and the states of power supply. (0x26)

1 st byte	Start bit (0xAA)
2 nd byte	Address(0x00~0xFE)
3 rd byte	Command (0x26)
4 th byte	Byte 0 of present output current value
5 th byte	Byte 1 of present output current value
6 th byte	Byte 0 of present output voltage value
7 th byte	Byte 1 of present output voltage
8 th byte	Byte 2 of present output voltage
9 th byte	Byte 3 of present output voltage
10 th byte	Power supply's state
11 th byte	To set the low byte of current value
12 th byte	To set the high byte of current value
13 th byte	Byte 0 of the maximum voltage value
14 th byte	Byte 1 of the maximum voltage value
15 th byte	Byte 2 of the maximum voltage value
16 th byte	Byte 3 of the maximum voltage value
17 th byte	Byte 0 of output voltage value
18 th byte	Byte 1 of output voltage value
19 th byte	Byte 2 of output voltage value
20 th byte	Byte 3 of output voltage value
21 st to 25 th byte	System reserve
26 th byte	Check sum

Note:

1. We use 4 bytes to represent the maximum voltage value as follows:

Byte 3	Byte 2	Byte1	Byte0
--------	--------	-------	-------

2. We use 1 byte to represent power supply's state. Each bit is defined as follows:

From higher bit to lower bit

7	6	5	4	3	2	1	0
---	---	---	---	---	---	---	---

0 bit : The output state, 0 is OFF, 1 is ON.

1 bit : Over heat protection, 0 is normal, 1 is abnormal.

2、 3 bit: The output mode, 1 is CV mode, 2 is CC mode,3 is Unreg mode.

4、 5、 6 bit : The fan speed, 0 is stop, 5 is the maximum fan speed.

7 bit : Operation state, 0 is front panel operation mode, 1 is remote control mode.

3. The frame format is the same as above

8. Entering the calibration mode (0x27)

1 st byte	Start bit(0xAA)
2 nd byte	Address(0x00~0xFE)
3 rd byte	Command(0x27)
4 th byte	Calibration protection state
5 th byte	Calibration password(0x28)
6 th byte	Calibration password(0x01)
7 th to 25 th byte	System reserve
26 th byte	Check sum

Note:

We use a byte to represent calibration protection state , each bit is defined as follows:

from higher bit to lower bit

7	6	5	4	3	2	1	0
---	---	---	---	---	---	---	---

0 bit : Protection state, 0 is to disable protection, 1 is to enable the protection.

9. Reading the calibration state (0x28)

1 st byte	Start bit(0xAA)
2 nd byte	Address(0x00~0xFE)
3 rd byte	Command(0x28)
4 th byte	Calibration protection state
5 th byte	System reserve
26 th byte	Check sum

10. Calibrating the voltage value (0x29)

1 st byte	Start bit(0xAA)
2 nd byte	Address(0x00~0xFE)
3 rd byte	Command(0x29)
4 th byte	Calibrated voltage points(point 1-3)
5 th to 25 th byte	System reserve
26 th byte	Check sum

Note: To calibrate the 3 points of voltage sequentially.

11. Sending the present output voltage to calibration program (0x2A)

1 st byte	Start bit (0xAA)
2 nd byte	Address(0x00~0xFE)
3 rd byte	Command(0x2A)

4 th byte	The byte 0 of present voltage value
5 th byte	The byte 1 of present voltage value
6 th byte	The byte 2 of present voltage value
7 th byte	The byte 3 of present voltage value
8 th to 25 th byte	System reserve
26 th byte	Check sum

12. Calibrate the current value (0x2B)

1 st byte	Start bit(0xAA)
2 nd byte	Address(0x00-0xFE)
3 rd byte	Command(0x2B)
4 th byte	Calibrated current points(point 1-2)
5 th to 25 th byte	System reserve
26 th byte	Check sum

Note: To calibrate the 2 points of the current value sequentially.

13. Sending the actual output current to calibration program (0x2C)

1 st byte	Start bit (0xAA)
2 nd byte	Address(0x00~0xFE)
3 rd byte	Command(0x2C)
4 th byte	The lower byte of the present current value
5 th byte	The higher byte of the present current value
6 th to 25 th byte	System reserve
26 th byte	Check sum

14. Save the calibration data to EEPROM (0x2D)

1 st byte	Start bit(0xAA)
2 nd byte	Address (0x00~0xFE)
3 rd byte	Command(0x2D)
4 th to 25 th byte	System reserve
26 th byte	Check sum

15. Setting calibration information (0x2E)

1 st byte	Start bit (0xAA)
2 nd byte	Address (0x00~0xFE)
3 rd byte	Command(0x2E)
4 th to 23 rd byte	Calibration information(ASIC code)
24 th byte	System reserve
25 th byte	System reserve
26 th byte	Check sum

16. Reading calibration information (0x2F)

1 st byte	Start bit (0xAA)
2 nd byte	Address (0x00~0xFE)
3 rd byte	Command (0x2F)
4 th to 23 rd byte	Calibration information(ASCII code)
24 th byte	System reserve
25 th byte	System reserve
26 th byte	Check sum

17. Reading product's model, series number and version information (0x31)

1 st byte	Start bit (0xAA)
2 nd byte	Address (0x00~0xFE)
3 rd byte	Command (0x31)
4 th to 8 th byte	Product model(ASIC code)
9 th byte	Lower byte of the software version
10 th byte	Higher byte of the software version
11 th to 20 th byte	Serial number(ASCII code)
21 st to 25 th byte	System reserve
26 th byte	Check sum

Note: For example, the serial number is 000045 , the product model is 1785B , and software version is V2.03, then the returned data is as follows:

AA	00	31	36	38	31	31	00	03	02	ZZ	ZZ	ZZ	ZZ	ZZ	ZZ	ZZ	ZZ	ZZ	ZZ	ZZ	XX	XX	XX	XX	XX	57
----	----	----	----	----	----	----	----	----	----	----	----	----	----	----	----	----	----	----	----	----	----	----	----	----	----	----

18. Restore the factory default calibration data (0x32)

1 st byte	Start bit (0xAA)
2 nd byte	Address(0x00~0xFE)
3 rd byte	Command(0x32)
4 th to 25 th byte	System reserve
26 th byte	Check sum

19 . Enable the local key (0x37)

1 st byte	Start bit (0xAA)
2 nd byte	Address (0x00-0xFE)
3 rd byte	Command (0x37)
4 th byte	Enable/disable local key (0 is disable, 1is enable)
5 th to 25 th byte	System reserve
26 th byte	Check sum code

Note: The local keys on the front panel are not allowed to use when the power supply is in remote mode. If the local key was enabled, user can press the numeric key 7 to change the remote mode to front panel operation mode and all local keys will work.

20. The return information of command operation in power supply (0x12)

1 st byte	Start bit (0xAA)
2 nd byte	Address (0x00~0xFE)
3 rd byte	Command(0x12)
4 th byte	Command checkout result
5 th to 25 th byte	System reserve
26 th byte	Check sum

Note: When the power supply receives a frame command, it will check the frame command, if the check sum is correct, then it will return to 0x80, if there is any error on setting parameter or over parameter, then it will return to 0xA0, if the command wasn't executed, then it will return to 0xB0, if the command isn't effective, then it will return to 0xC0. Or otherwise, it will return to 0x80.

Chapter 5 PV1785B-1788 Software

5.1 Introduction

Software PV1785B-1788 is control software for IT1785B-1788 series programmable power supply. It can work with all single-output power supply models. Please make sure that you purchased communication cable, and use it to connect the power supply and computer before the communicating. This software can accomplish all the functions of the power supply, such as setting constant voltage, setting constant current, max voltage etc. Also you can make quickly settings or make a program for the output voltage and current by the computer. In addition, PV1785B-1788 offer a GO/NG test function for automatic factory testing. It brings you much convenience when you use the power supply.

5.2 System Installation

1 . Requirements for the computer

Pentium III or Pentium IV processor-based personal computer
Windows 98/2000/XP or Windows NT4.0

2. Insert the CD-Rom which supplied with the instrument to the CD driver, and install the software step by step according to the instructions.

5.3 Functions of PV-1785B-1788

Start the software PV1785B-1788, the windows is as follows:

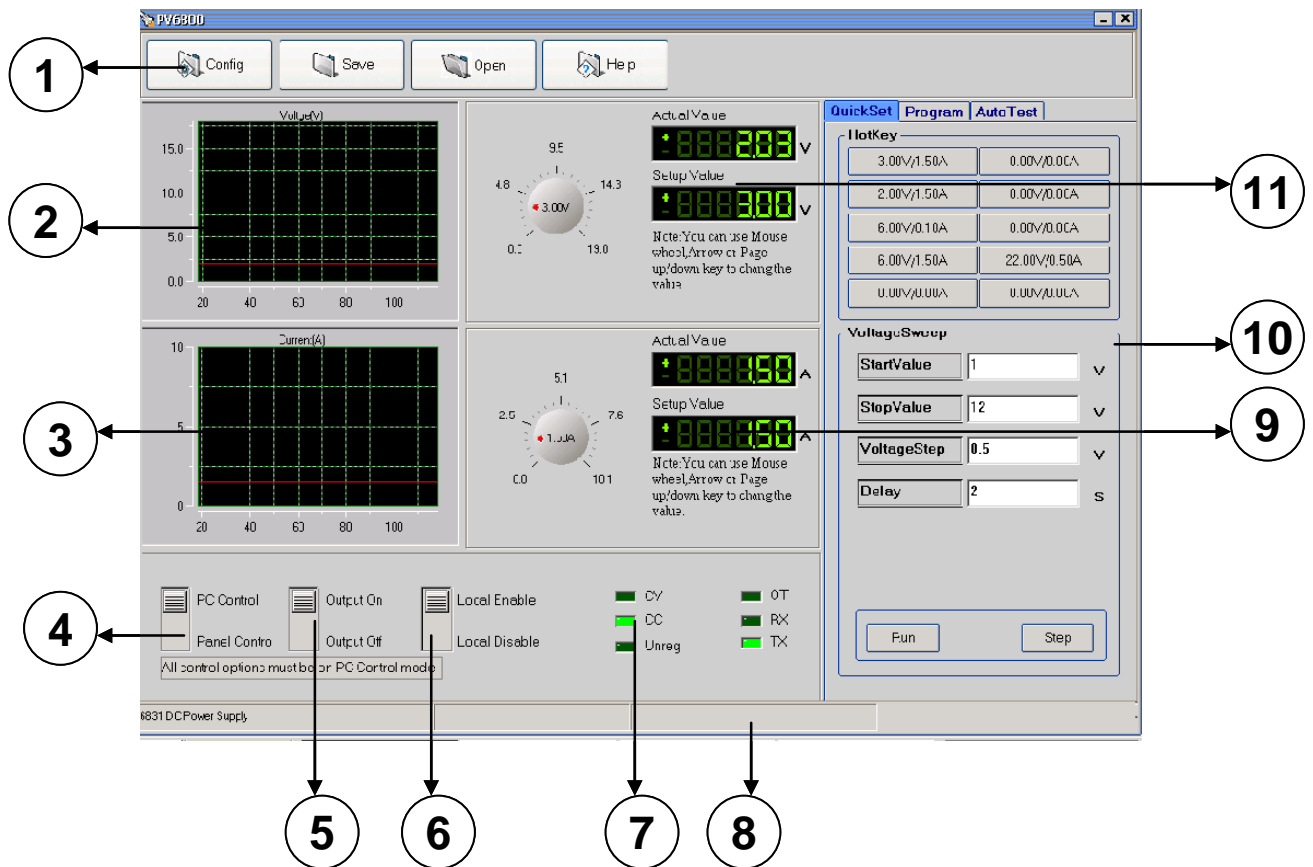

- ① Configure the software operation environments.
- ② Voltage chart, it can show you a chart of the voltage.
- ③ Current chart: it can show you a chart of the current.
- ④ To set the remote mode of power supply.
- ⑤ To set the output state ON/OFF
- ⑥ To enable the local numeric key ⑦, it means that if you select “Enable” on this button, when the power supply is under remote control mode, you can press numeric key ⑦ to change the control mode to front panel control mode.
- ⑦ Annunciators display.
- ⑧ Status bar, it can show you the power supply model, communication status and operation status.
- ⑨ To set current value, use the rotary knob to set the current value, the setup value and measurement value will be displayed.
- ⑩ To make a program of voltage and current values for the power supply, or to set the output value quickly.
- ⑪ Using the rotary knob to set the voltage value, the setup value and present value will be displayed in the 2 indicators.

5.3.1 Configure the system

The first step for communication is to configure the system, click Configure button  , the windows will display as follows:

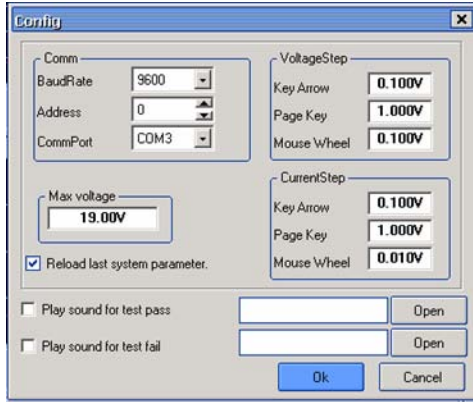

- 1) Comm: to set the communication port, baud rate and address.
- 2) Max voltage: to set a maximum voltage value in the voltage range. For example, the voltage range of IT6822 is 0~32V, then you can set a maximum voltage at 24V.
- 3) Voltage/Current step: to set the step size of Arrow key, page up/down key, and Mouse-wheel. When you set the value by clicking the knob, you can use the arrow keys (\uparrow , \downarrow , \leftarrow , \rightarrow), page up/down keys or mouse wheel to adjust the value more slightly.
- 4) Reload last parameter: if you select it, then it will reload the parameter settings of last time you close this software.



Note : When you set the communication port, please make sure that the baud rate and address of the computer are the same as the power supply.

5.3.2 Status bar

Status bar will give you the communication information. When the communication is successful, the status bar will display as follows:



1. Model number: it will display the real part number of the field power supply which detected by the computer. (6811/6812/6821/6822/6823.....).
2. Communication status (**Communication successful/Communication waiting**), if **Communication waiting** appears here for more than 10 seconds, you need to check if there is any connection failure between computer and power supply. After confirming the effective connection, then re-configure the baud rate, address, comport etc, to make sure the same baud rate and address between power supply and computer.

5.3.3 Setting Voltage and current

1. Setting voltage/current by rotary knob

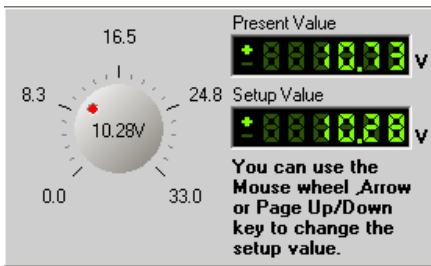

Use mouse to click on the rotary knob and move mouse to change the value. You also can use mouse wheel, or Page Up/Down keys and arrow keys (↑, ↓, ←, →) from the keyboard to change the voltage value more slightly. The setup value will be displayed on the second line indicator.

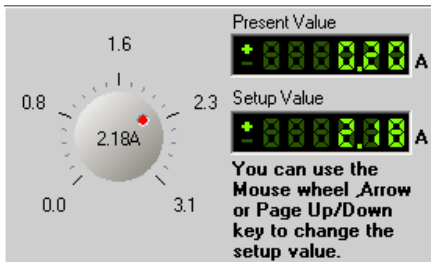

Use mouse to click on the rotary knob and move mouse to change the value. Also you can use mouse wheel, Page Up/Down keys and arrow keys (↑, ↓, ←, →) from the keyboard to change the current value more slightly. The setup value will be displayed on the second line indicator.



Note: Before you set the current and voltage value from the computer, please change the operation mode to PC Control mode by pressing **button**.

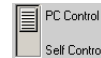

2. Quickly setting

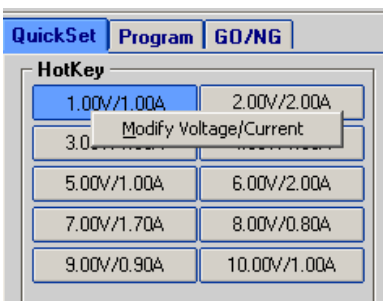

Hot Key: Right-click each Hotkey Button, it will display as “Modify Voltage/Current”. Click “Modify/Voltage/Current”, it will display as follows, change the voltage/current value as you desired, then click OK button to confirm.

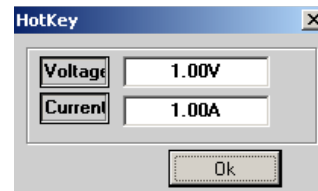

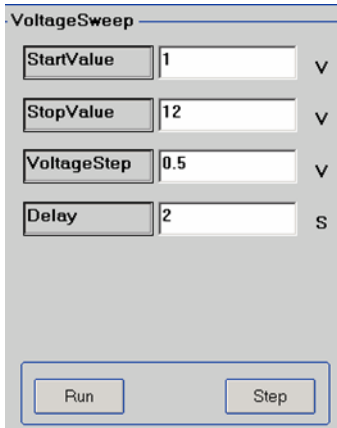

Voltage Sweep: To set voltage sweep. For example, StartValue=1V, Stop Value=12V, Voltage Step=0.5V, TimeDelay=2s. When you click the “Run” button, the voltage will change according to the voltage sweep setup value, display as follows: then you can click “Stop” button to stop the voltage sweep.



3. Program setting

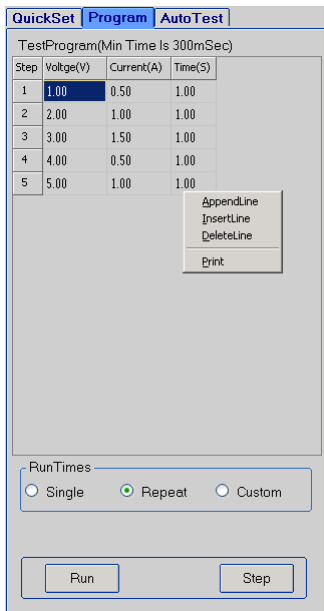

Program: Right-click on the Program area, the program tools (AppendLine, Insert Line, DeleteLine) will appear on the window. Click the tools to program the steps.

Double-click on each value to change them from key board as you desired. Also you can change the time unit (hour/minute/second) by clicking on “Sec”.

After programming, you can select a run mode for your program. (Run mode includes Once, Repeat and Custom).

Click “Run” button to send the program settings to the power supply. The power supply’s output will respond to the program.

Click “Stop” button to stop sending the program settings to the power supply. The power supply state will return to the state before the program running.

5.3.4. GO/NG Test Function

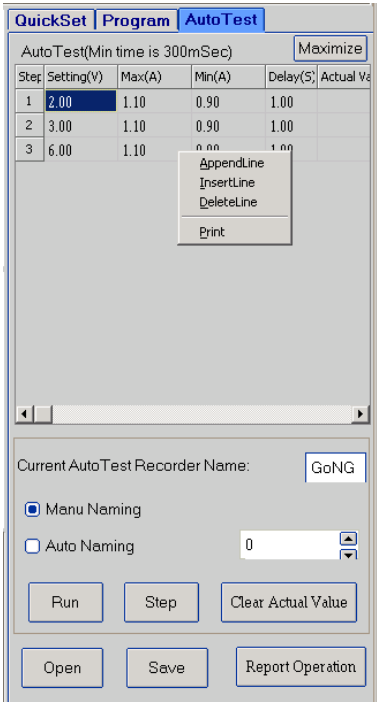

GO/NG is an auto test function, to test if the EUT (equipment under test) can meet the specification. To use this function, follow up the steps below:

1. Right-click on the window, the edit tools (Append a line, Insert a line, Delete a line, Delete Select etc.) will appear on the window. Use the edit tools to edit the test steps.
2. To set the Voltage, Max Amps, Min Amps and Delay time according to the specifications of the EUT.
3. Click the Run button to start the test. If the Real Amps of all steps are in the range of Min Amps to Max Amps, then the EUT will pass the test, the Pass window will appear.
4. If there is a Real Amps beyond the range in any step, the EUT will not pass the test.



5.3.5 Save and Open

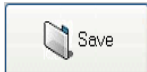

To save the program settings, quickly settings, voltage sweep settings and GO/NG settings as PAR file.

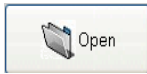

To open the PAR file for reloading the program settings, quickly settings, voltage sweep settings and GO/NG settings.

5.3.6 Present Voltage/Current Chart

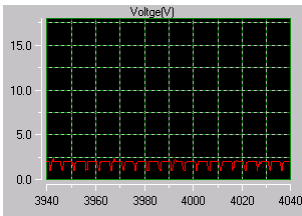

Double click the voltage chart, the voltage chart will be enlarged and will display as more details.

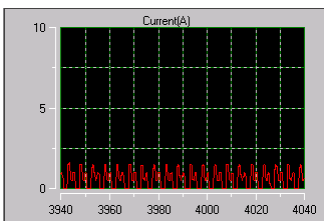
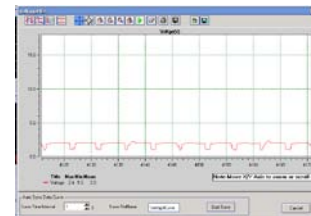
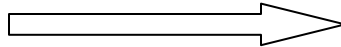

Double click the current chart, the current chart will be enlarged and will display with more details.

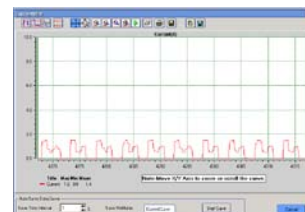
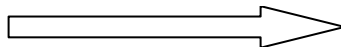

5.3.7 Chart Description

The voltage and current chart can help you to analyze voltage and current changes more easily. We take the voltage chart as the example to let you know how to use it. The chart window is as follows:

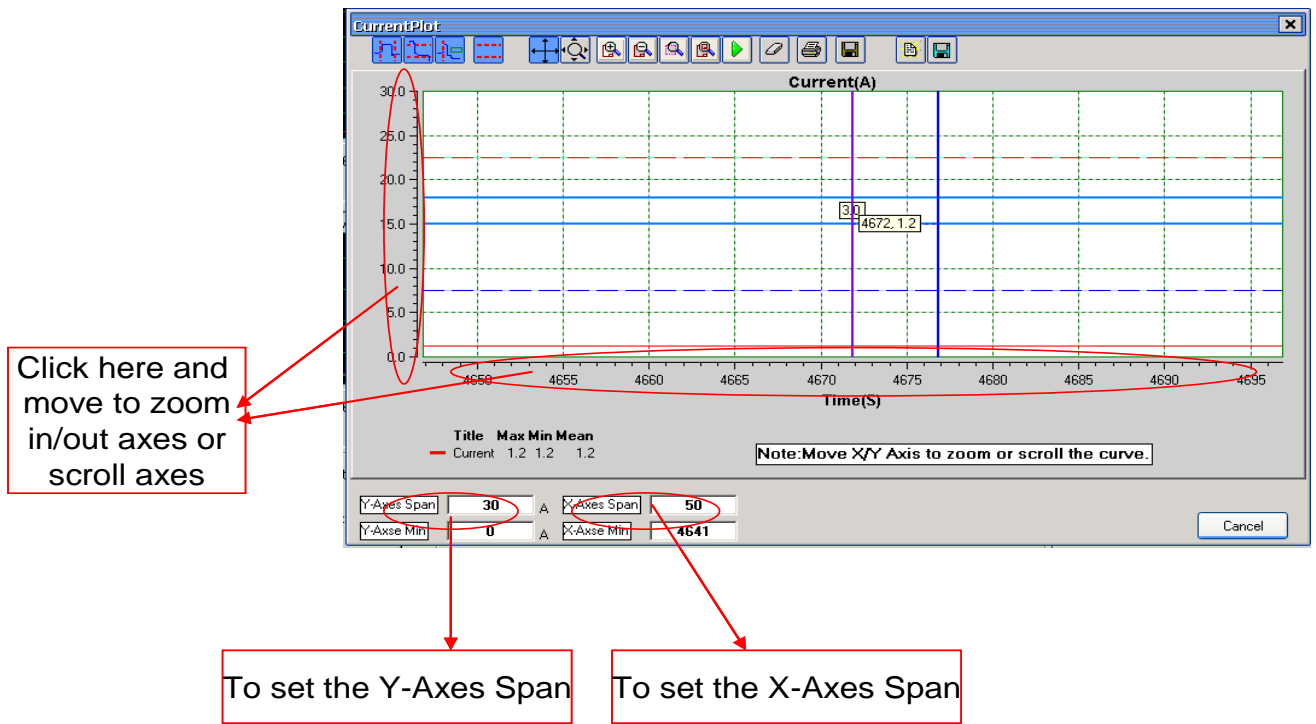

- Vertical marker
- Horizontal marker
- XY Value marker
- Limit range between the minimum value and maximum value.
- Scroll axes mode
- Zoom in/out axes mode
- Zoom out
- Zoom in
- Save the chart as a .BMP file.
- Clear all data
- Resume tracking
- Auto scale
- Print the chart
- Zoom rectangle

SERVICE INFORMATION

Warranty Service: Please go the support and service section on our website www.bkprecision.com to obtain a RMA #. Return the product in the original packaging with proof of purchase to the address below. Clearly state on the RMA the performance problem and return any leads, probes, connectors and accessories that you are using with the device.

Non-Warranty Service: Please go the support and service section on our website www.bkprecision.com to obtain a RMA #. Return the product in the original packaging to the address below. Clearly state on the RMA the performance problem and return any leads, probes, connectors and accessories that you are using with the device. Customers not on an open account must include payment in the form of a money order or credit card. For the most current repair charges please refer to the service and support section on our website.

Return all merchandise to B&K Precision Corp. with pre-paid shipping. The flat-rate repair charge for Non-Warranty Service does not include return shipping. Return shipping to locations in North America is included for Warranty Service. For overnight shipments and non-North American shipping fees please contact B&K Precision Corp.

B&K Precision Corp.
22820 Savi Ranch Parkway
Yorba Linda, CA 92887
www.bkprecision.com
714-921-9095

Include with the returned instrument your complete return shipping address, contact name, phone number and description of problem.

LIMITED ONE-YEAR WARRANTY

B&K Precision Corp. warrants to the original purchaser that its products and the component parts thereof, will be free from defects in workmanship and materials for a period of one year from date of purchase.

B&K Precision Corp. will, without charge, repair or replace, at its option, defective product or component parts. Returned product must be accompanied by proof of the purchase date in the form of a sales receipt.

To obtain warranty coverage in the U.S.A., this product must be registered by completing a warranty registration form on our website www.bkprecision.com within fifteen (15) days of purchase.

Exclusions: This warranty does not apply in the event of misuse or abuse of the product or as a result of unauthorized alterations or repairs. The warranty is void if the serial number is altered, defaced or removed.

B&K Precision Corp. shall not be liable for any consequential damages, including without limitation damages resulting from loss of use. Some states do not allow limitations of incidental or consequential damages. So the above limitation or exclusion may not apply to you.

This warranty gives you specific rights and you may have other rights, which vary from state-to-state.

B&K Precision Corp.
22820 Savi Ranch Parkway
Yorba Linda, CA 92887
www.bkprecision.com
714-921-9095

BK PRECISION®

22820 Savi Ranch Parkway
Yorba Linda, CA 92887
www.bkprecision.com

© 2008 B&K Precision Corp.

Printed in China

v020509